

B 3/2

14
13
12
11
10
9
8
7
6
5
4
3
2
1
0 [cm]

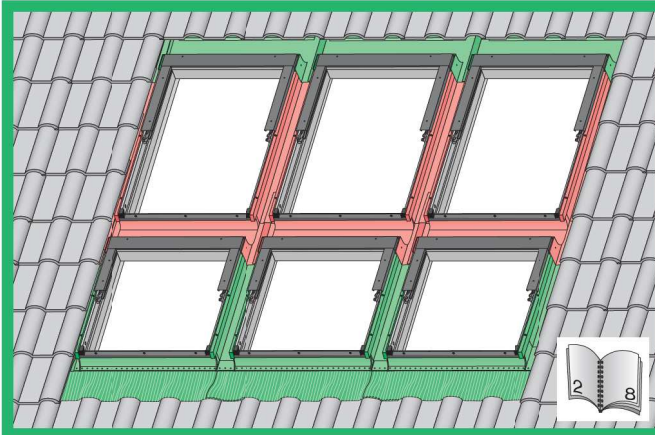

KHN+KXN
KHV+KXV

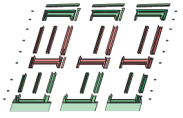

max 90mm



KZN+KXN
KZV+KXV
KZJ+KXJ

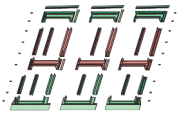

max 45mm

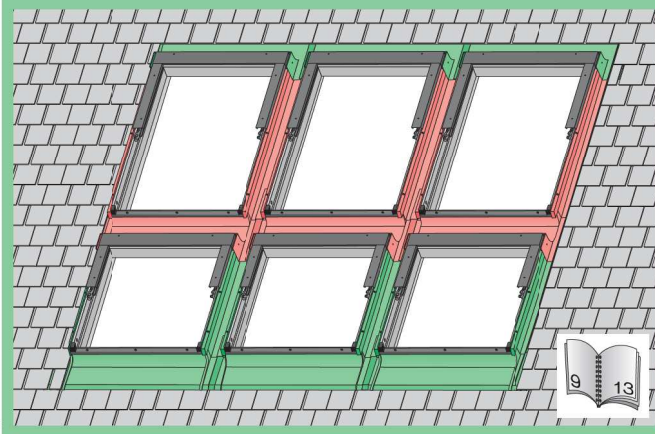

KSN+KXN
KSV+KXV
KSJ+KXJ

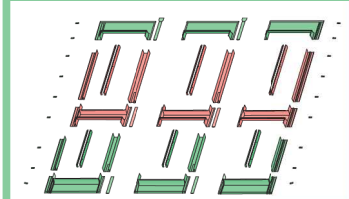

max 5mm

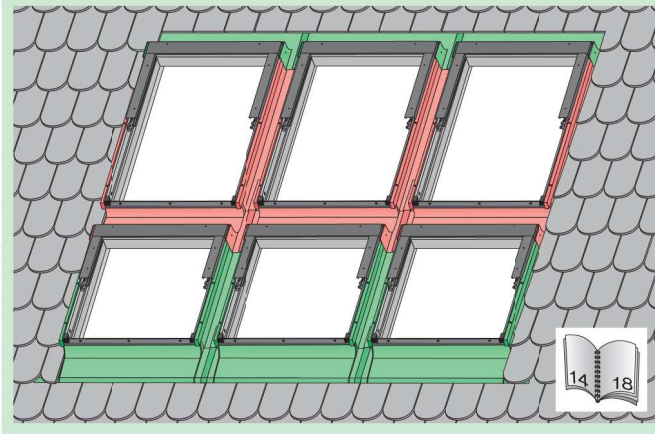

KLN₍₁₋₃₎+KLN₍₄₋₆₎
KLV₍₁₋₃₎+KLV₍₄₋₆₎
KLJ₍₁₋₃₎+KLJ₍₄₋₆₎

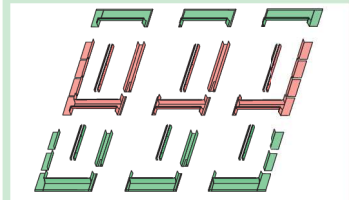

max 15mm (N)
max 5mm (V)
max 5mm (J)



	max 90mm KHN-1+KHN-2+KHN-3+ KXN-4+KXN-5+KXN-6		
	KHV-1 +KHV-2 +KHV-3 + KXV-4 +KXV-5 +KXV-6		
	-	-	-

	max 45mm KZN-1+KZN-2+KZN-3+ KXN-4+KXN-5+KXN-6		
	KZV-1 +KZV-2 +KZV-3 + KXV-4 +KXV-5 +KXV-6		
	KZJ-1 +KZJ-2 +KZJ-3 + KXJ-4 +KXJ-5 +KXJ-6		

	max 5mm KSN-1+KSN-2+KSN-3+ KXN-4+KXN-5+KXN-6		
	KSV-1 +KSV-2 +KSV-3 + KXV-4 +KXV-5 +KXV-6		
	KSJ-1 +KSJ-2 +KSJ-3 + KXJ-4 +KXJ-5 +KXJ-6		

max 15mm (N) max 5mm (V) max 5mm (J) 	KLN-1+KLN-2+KLN-3+ KLN-4+KLN-5+KLN-6		
	KLV-1 +KLV-2 +KLV-3 + KLV-4 +KLV-5 +KLV-6		
	KLJ-1 +KLJ-2 +KLJ-3 + KLJ-4 +KLJ-5 +KLJ-6		



max 90mm

KHN-1 + KHN-2 + KHN-3 + KXN-4 + KXN-5 + KXN-6
 KHV-1 + KHV-2 + KHV-3 + KXV-4 + KXV-5 + KXV-6



max 45mm

KZN-1 + KZN-2 + KZN-3 + KXN-4 + KXN-5 + KXN-6
 KZV-1 + KZV-2 + KZV-3 + KXV-4 + KXV-5 + KXV-6
 KZJ-1 + KZJ-2 + KZJ-3 + KXJ-4 + KXJ-5 + KXJ-6

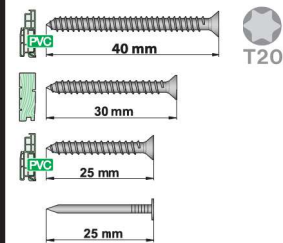

T20

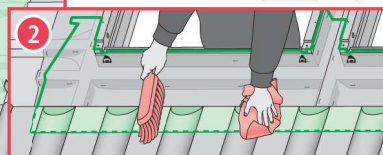
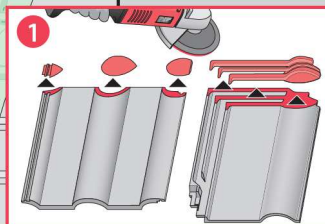
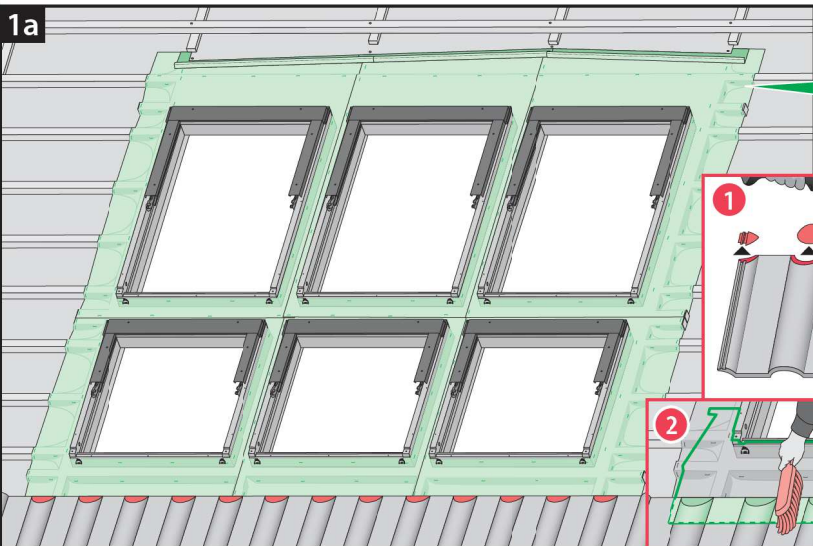
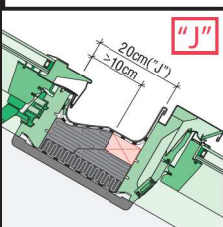
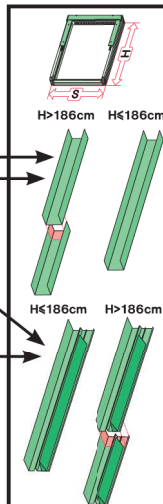
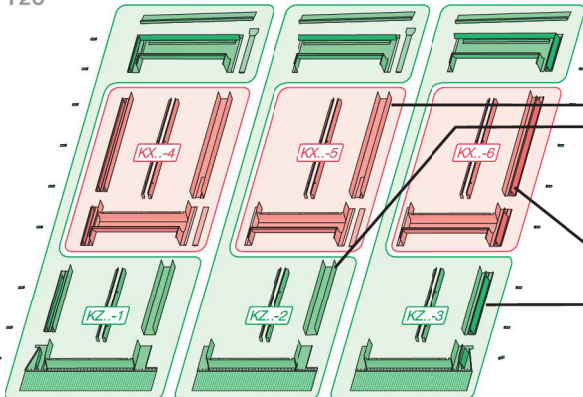

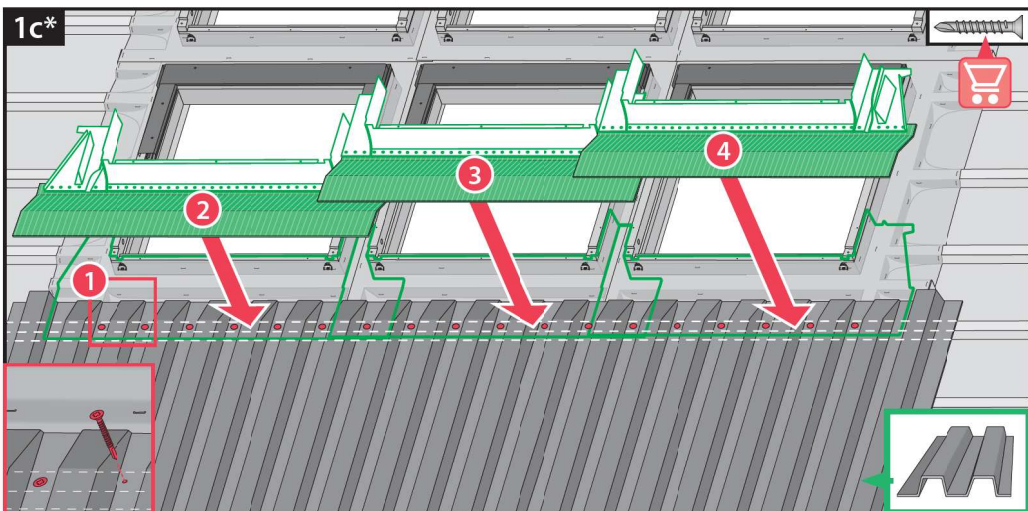
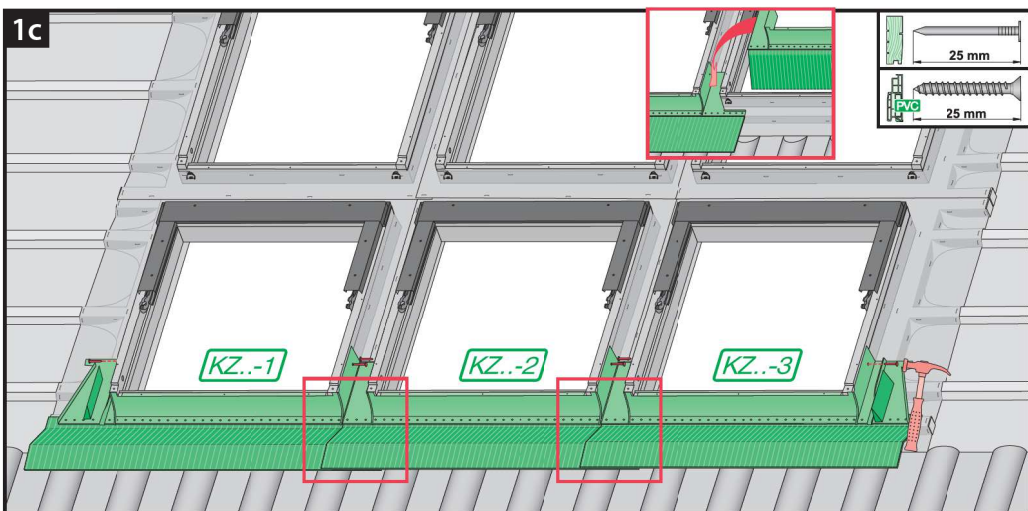
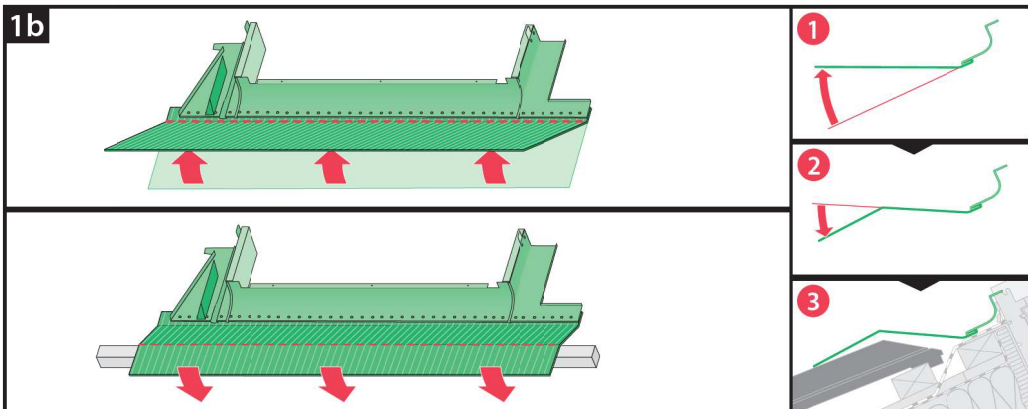

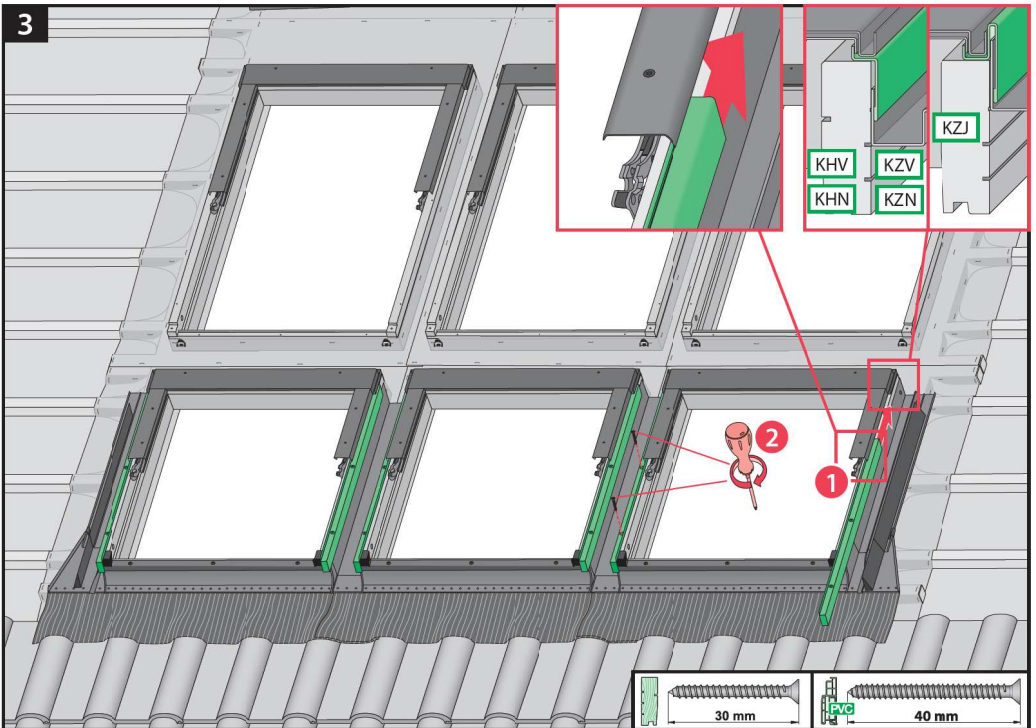
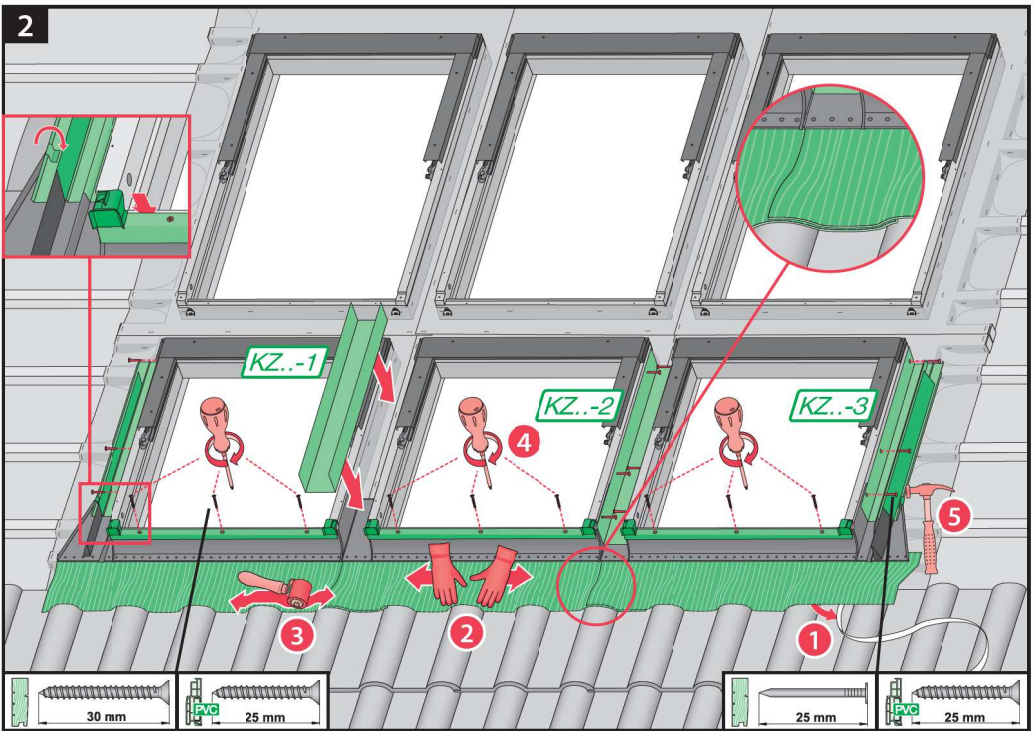

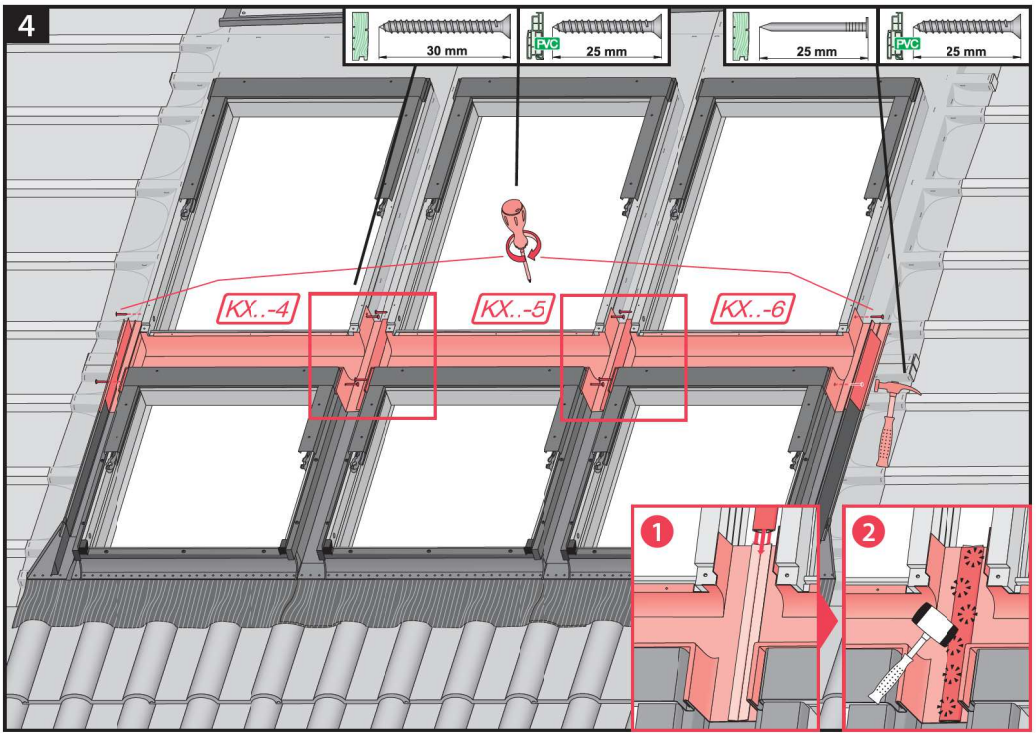

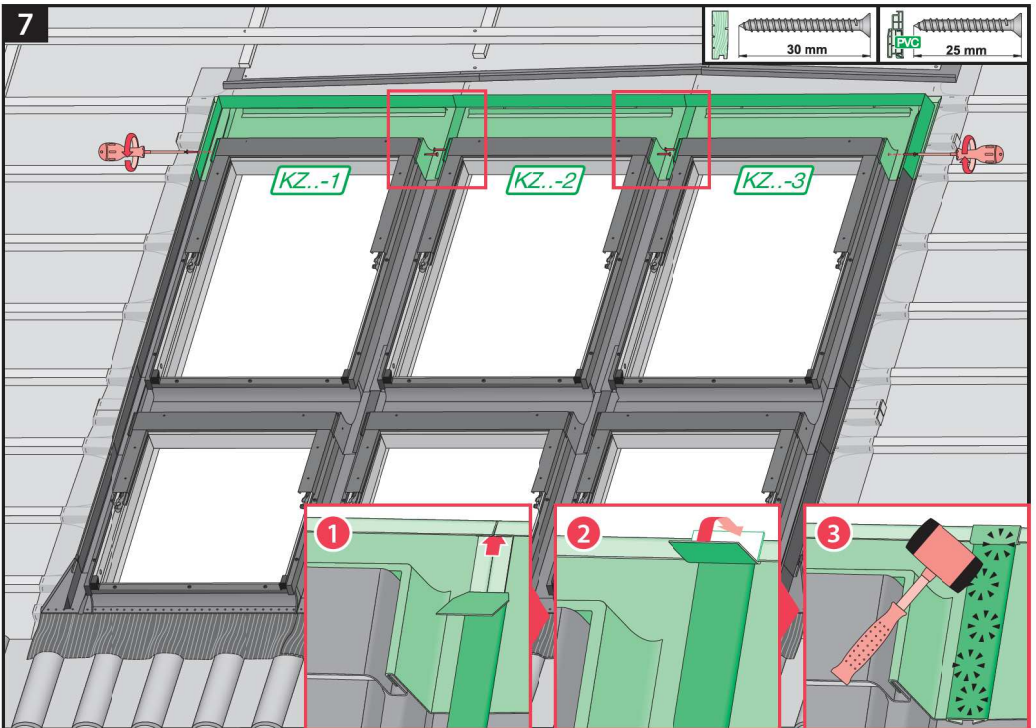
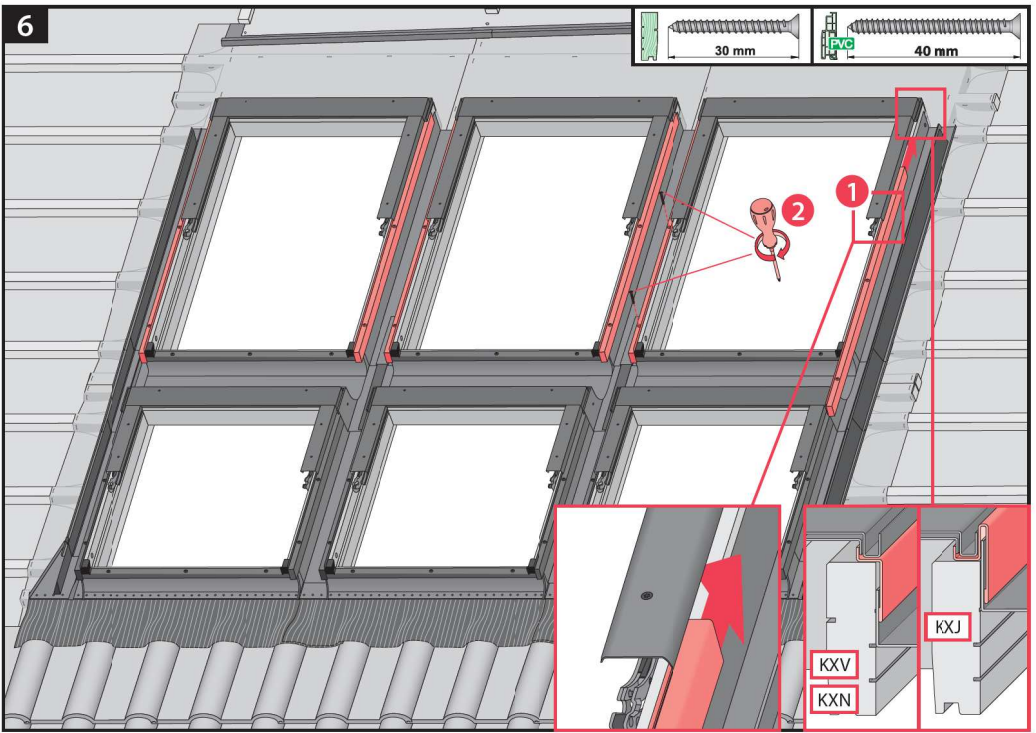

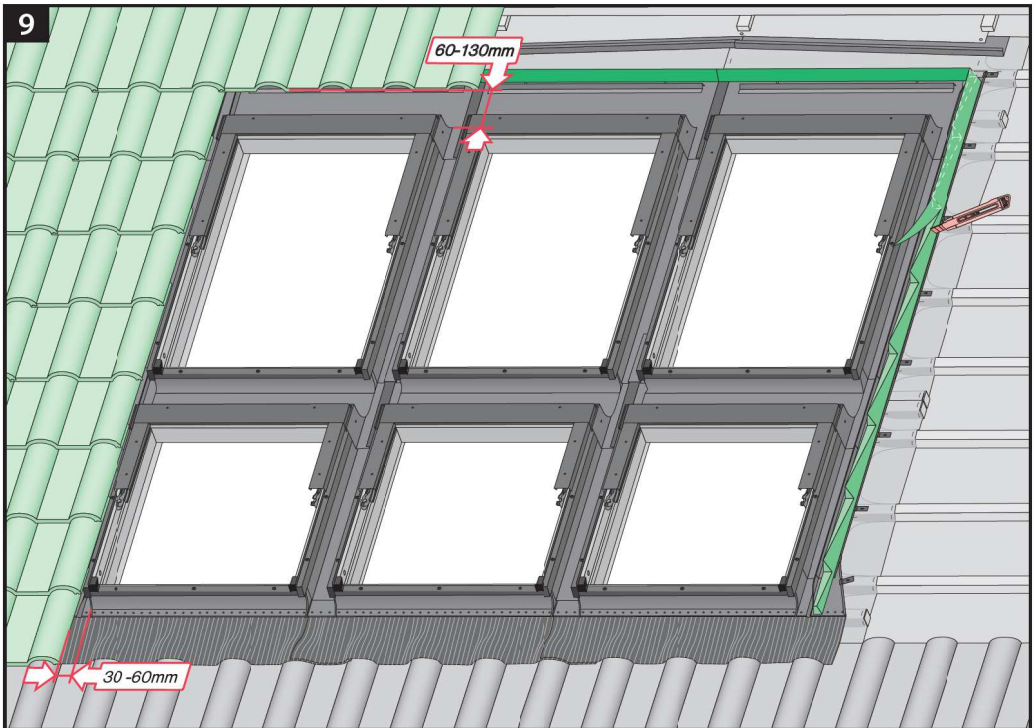
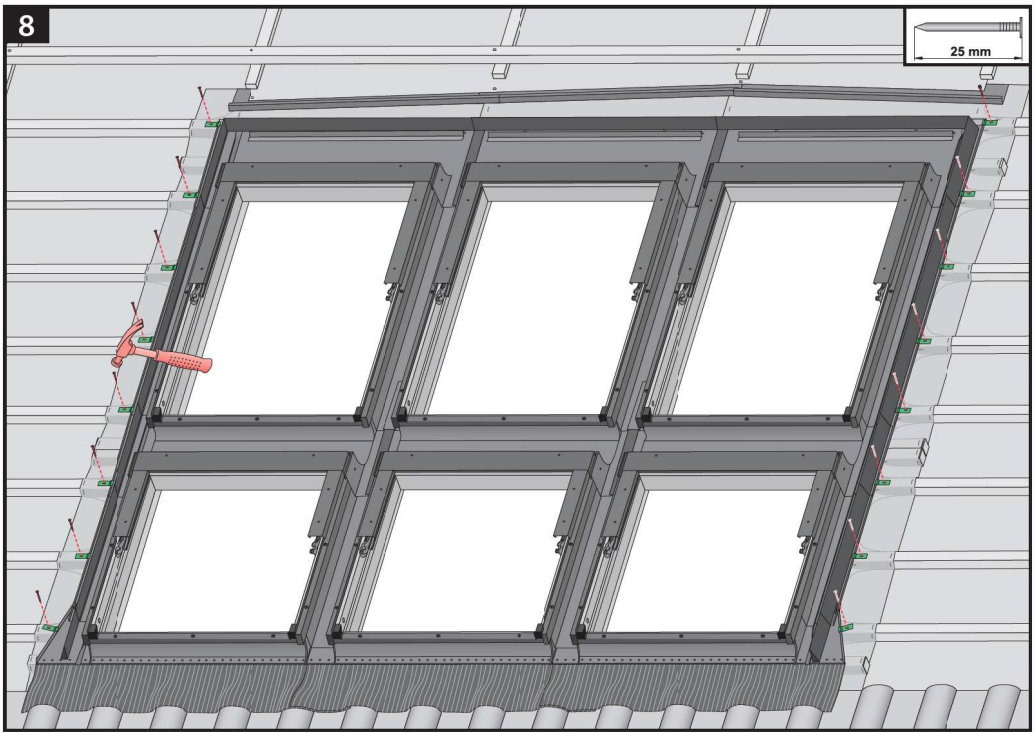



KSN-1 + KSN-2 + KSN-3 + KXN-4 + KXN-5 + KXN-6
KSV-1 + KSV-2 + KSV-3 + KXV-4 + KXV-5 + KXV-6
KSJ-1 + KSJ-2 + KSJ-3 + KXJ-4 + KXJ-5 + KXJ-6

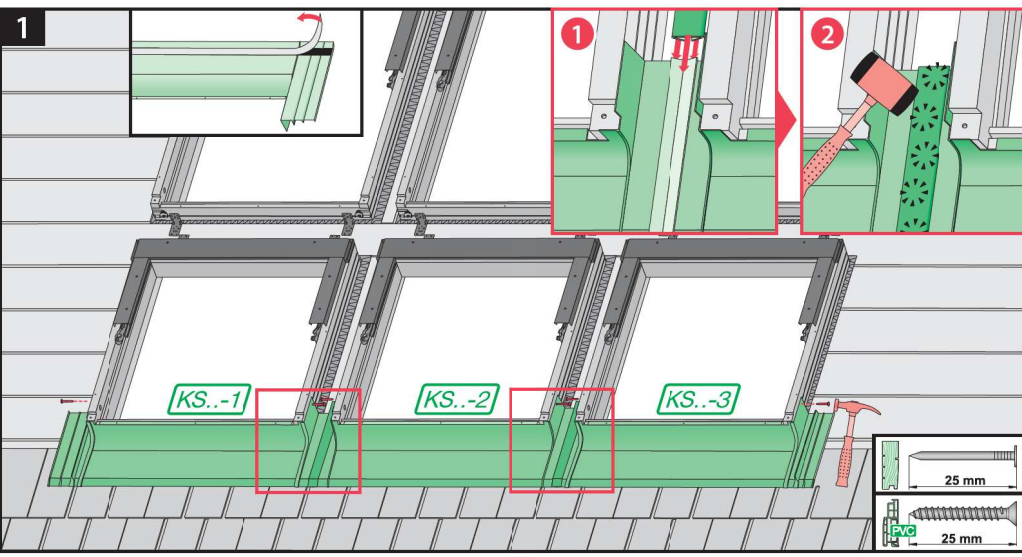
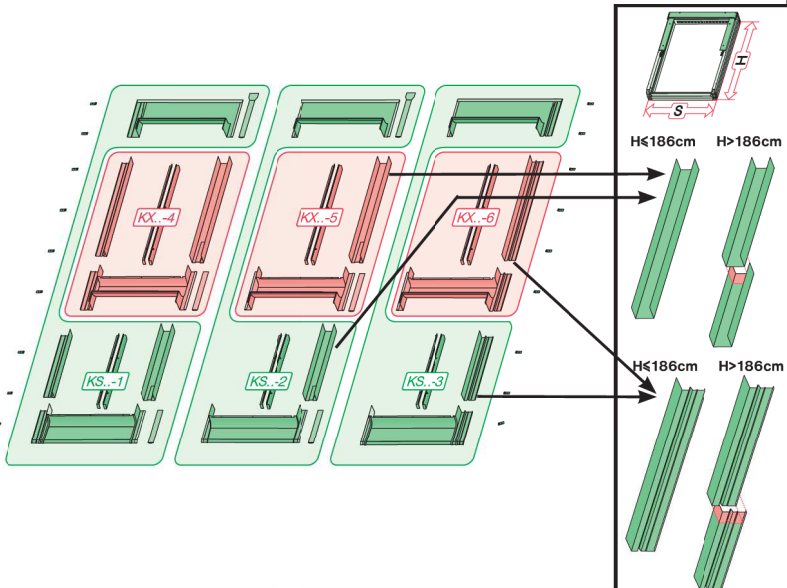
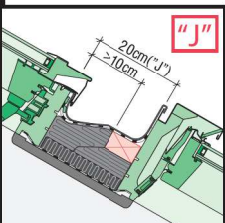
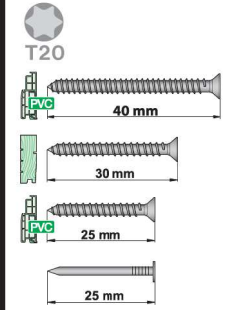

2

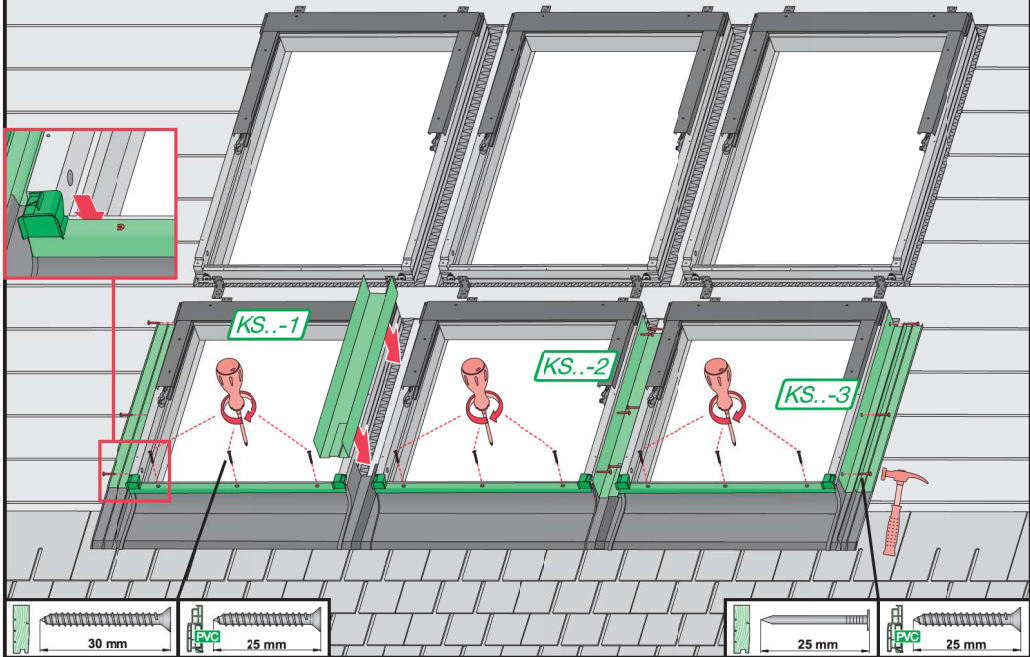

3

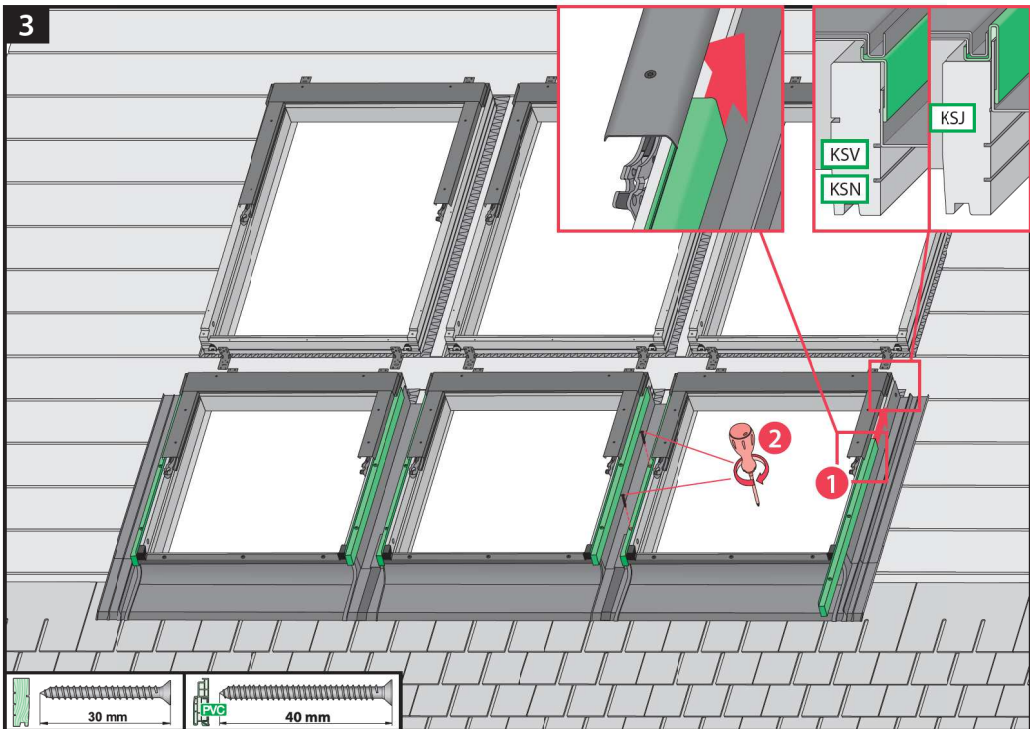

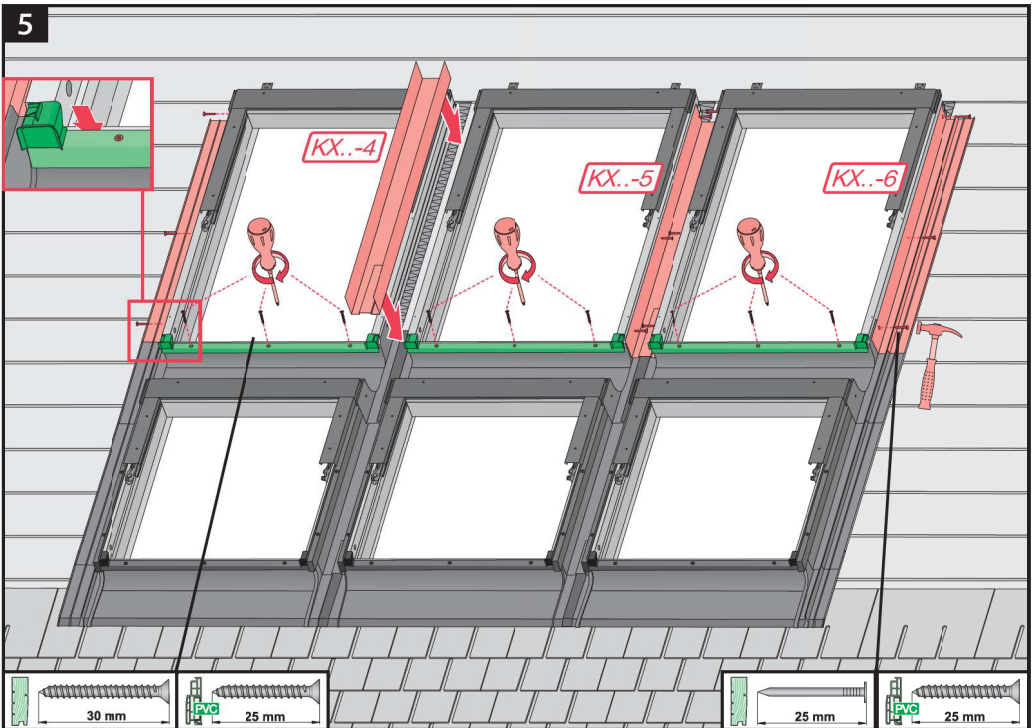
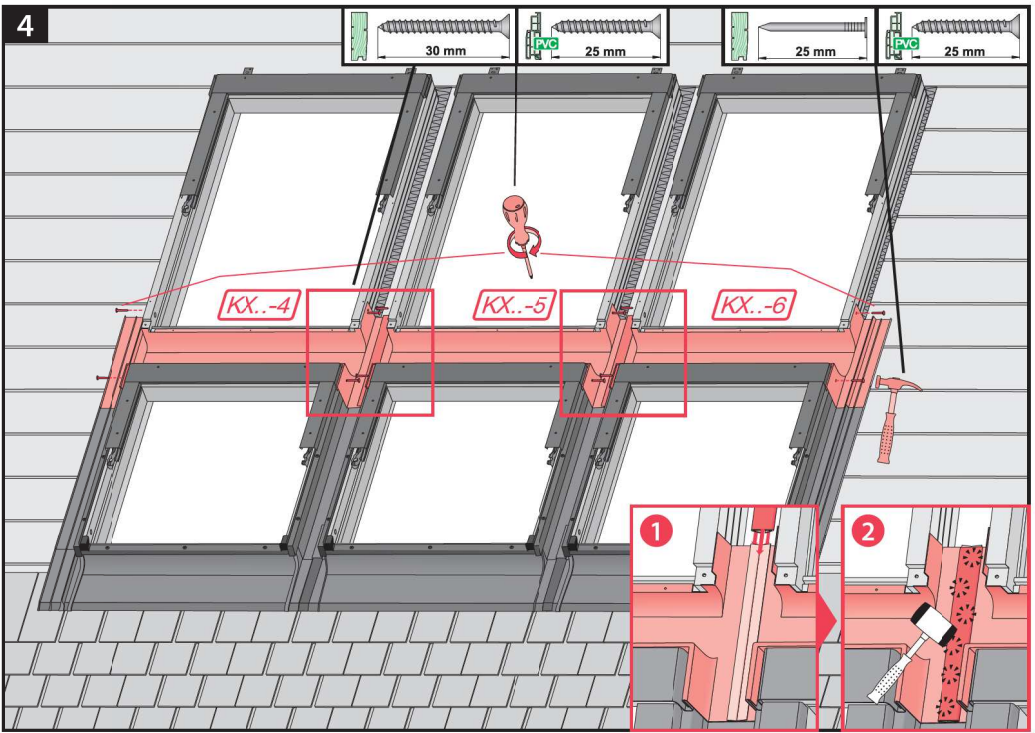

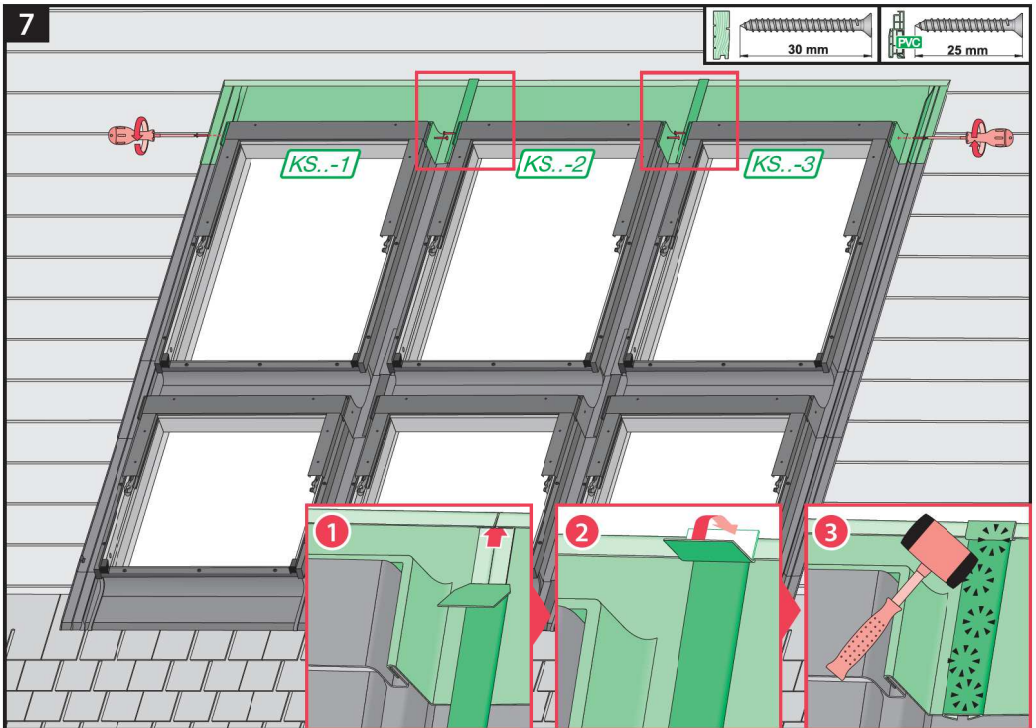
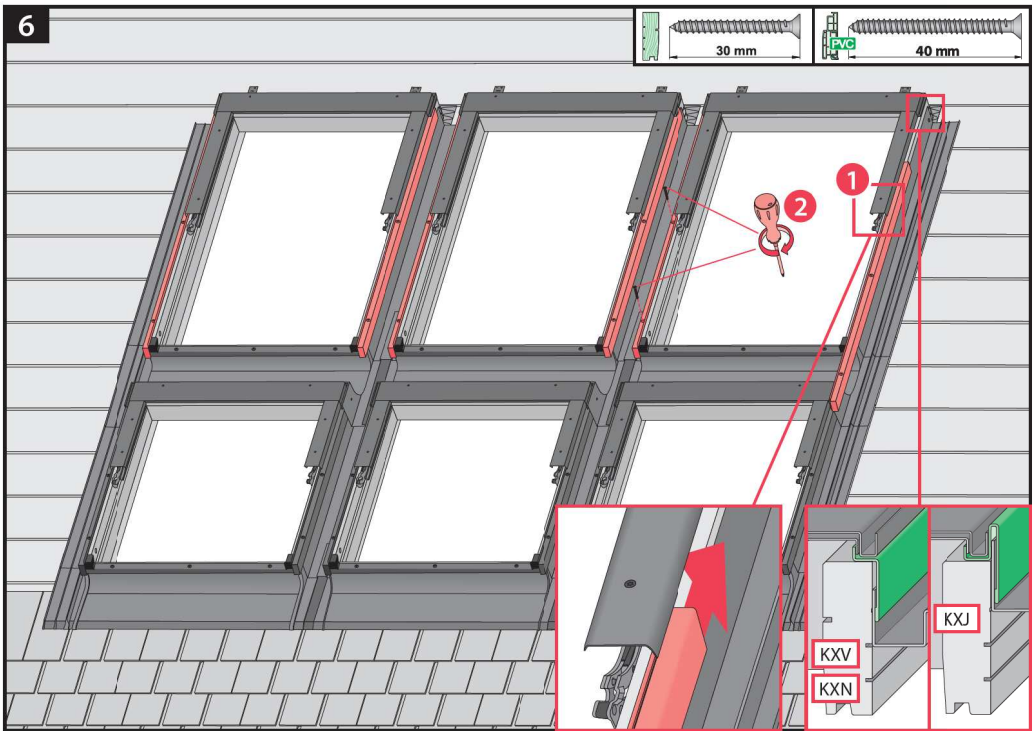

8

25 mm

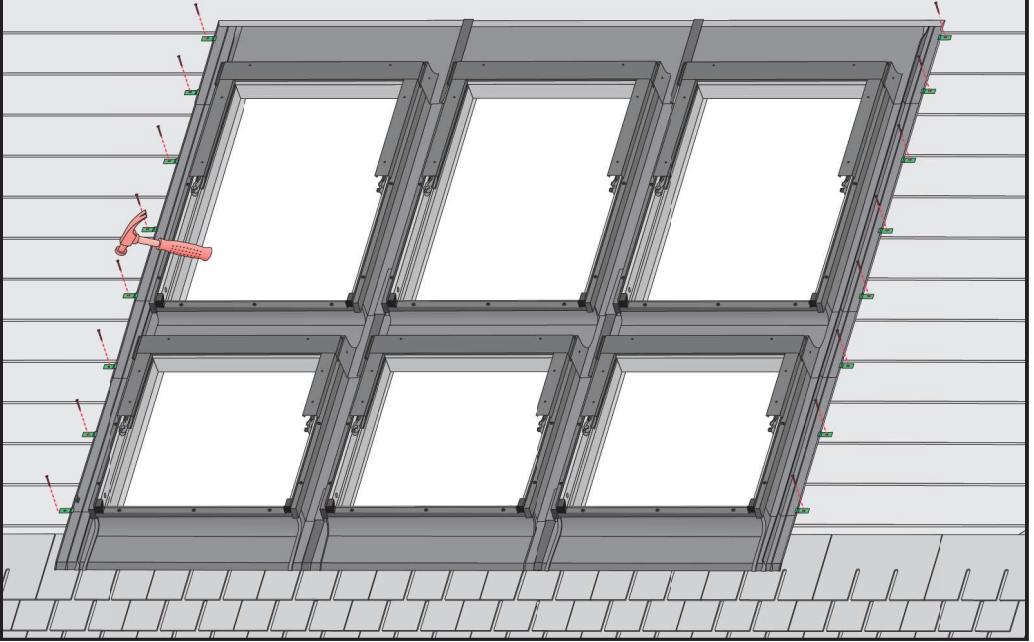

9

60-100mm

30-60mm

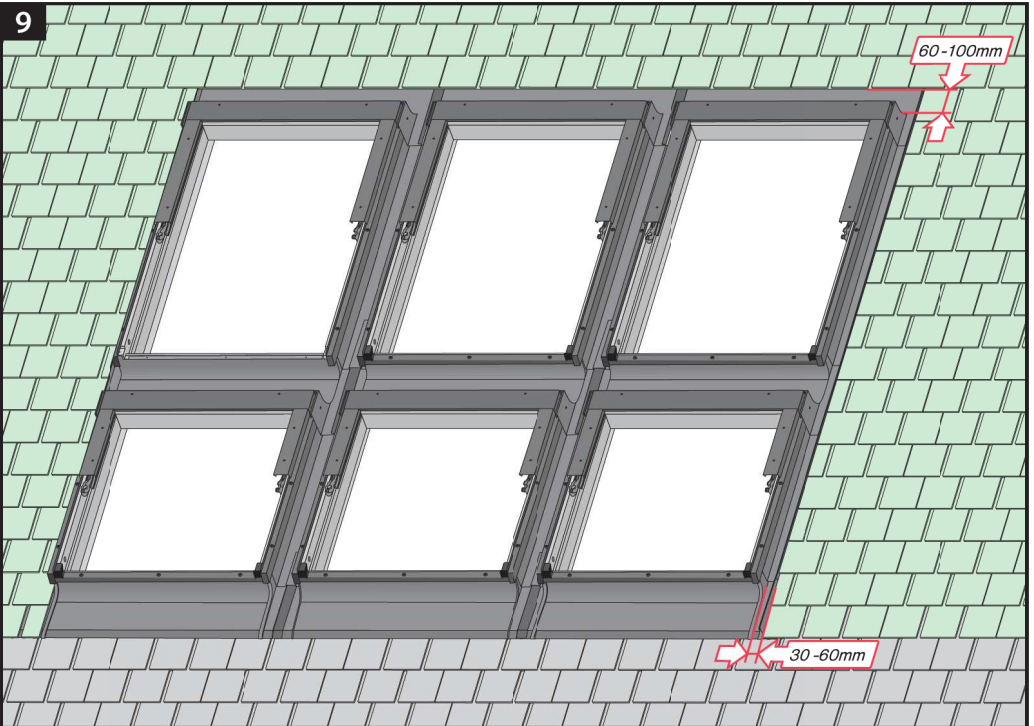

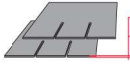
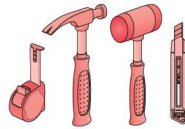

max 5mm (V,J)
max 15mm (N)

KLN-1+KLN-2+KLN-3+KLN-4+KLN-5+KLN-6
KLV-1+KLV-2+KLV-3+KLV-4+KLV-5+KLV-6
KLJ-1+KLJ-2+KLJ-3+KLJ-4+KLJ-5+KLJ-6



T20

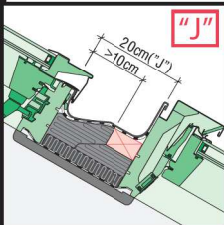
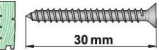
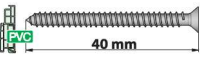

1/2''

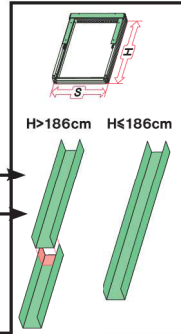
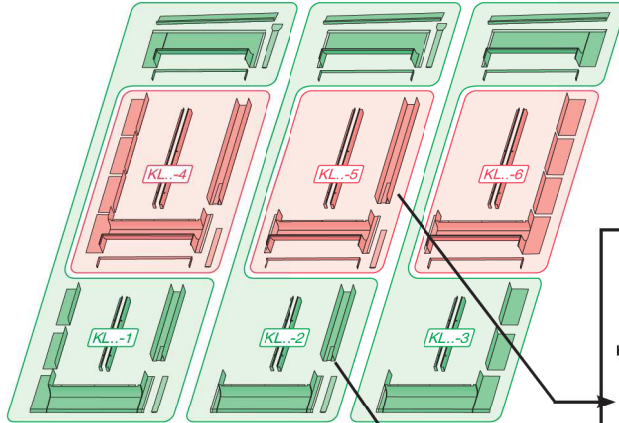

1a

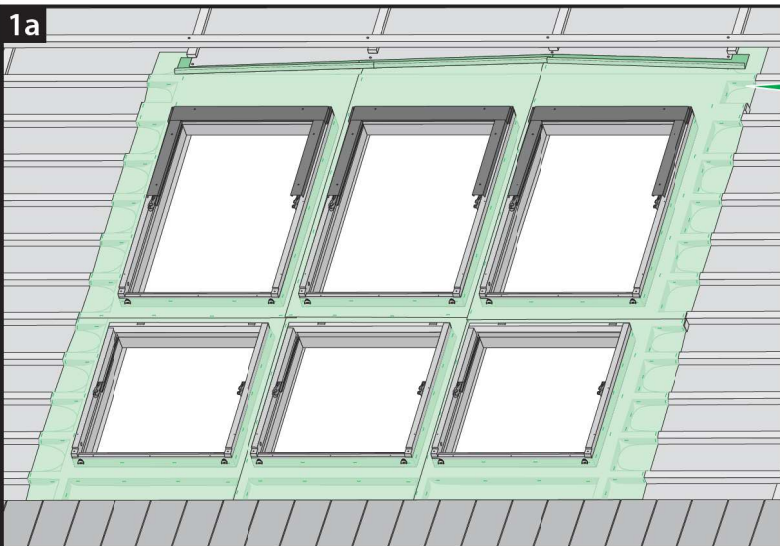

XDP®



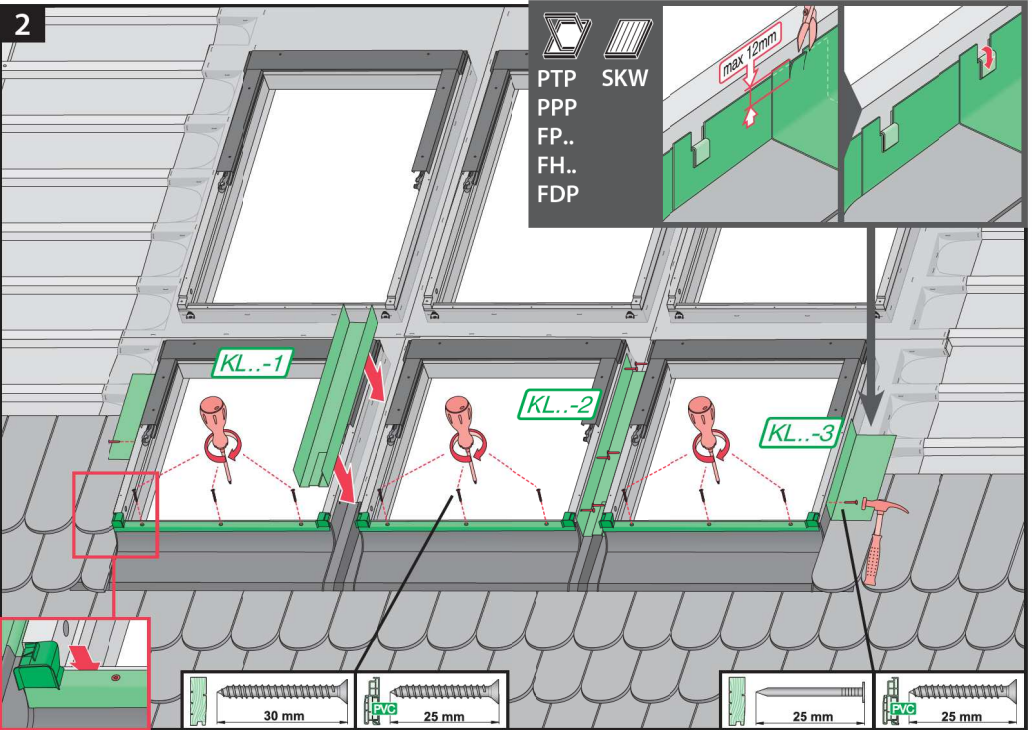
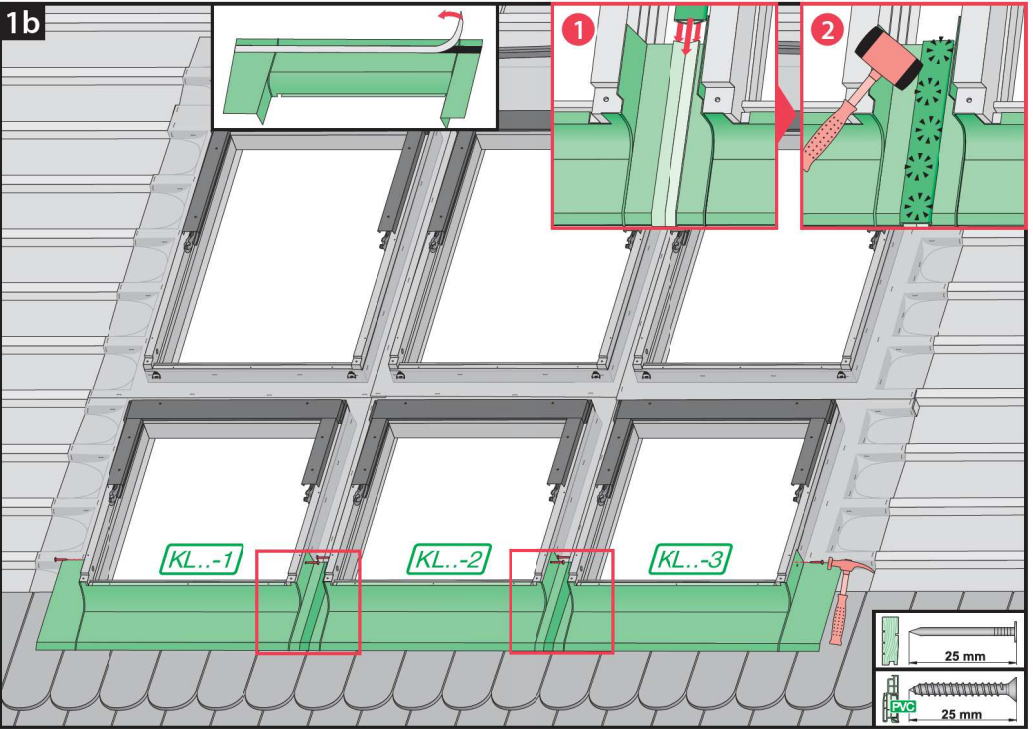

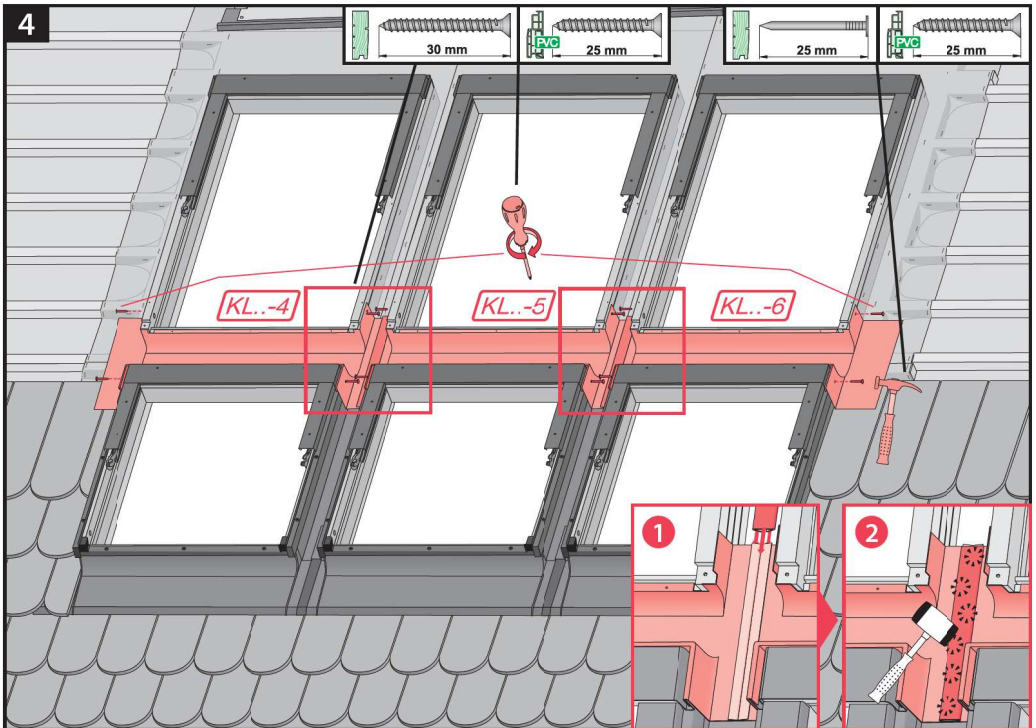
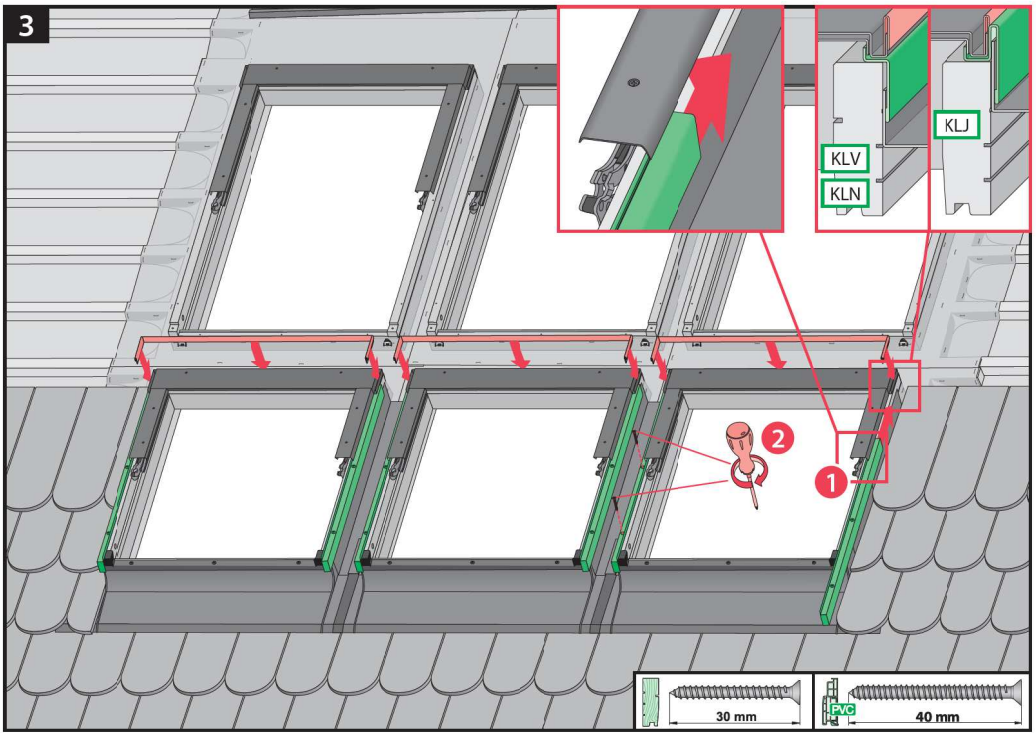

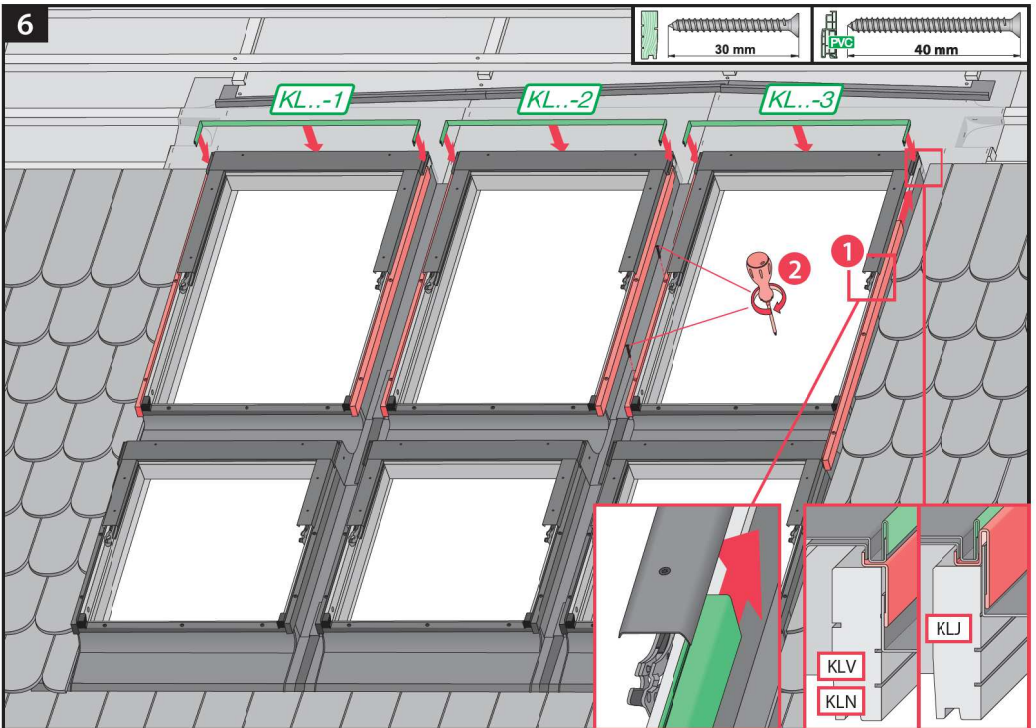
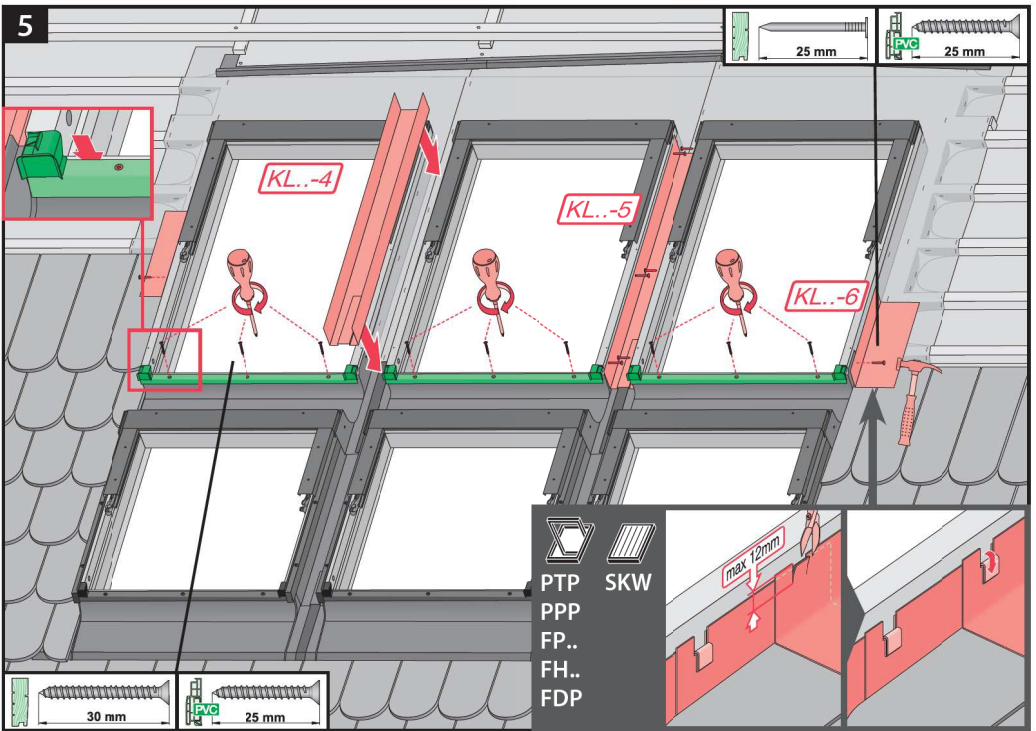

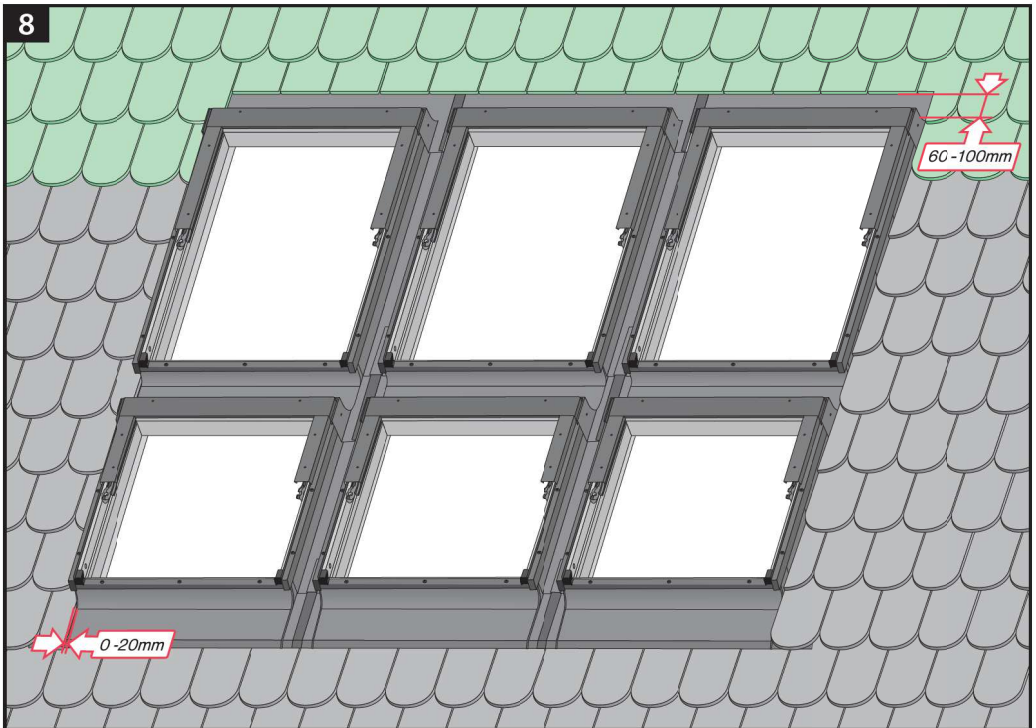
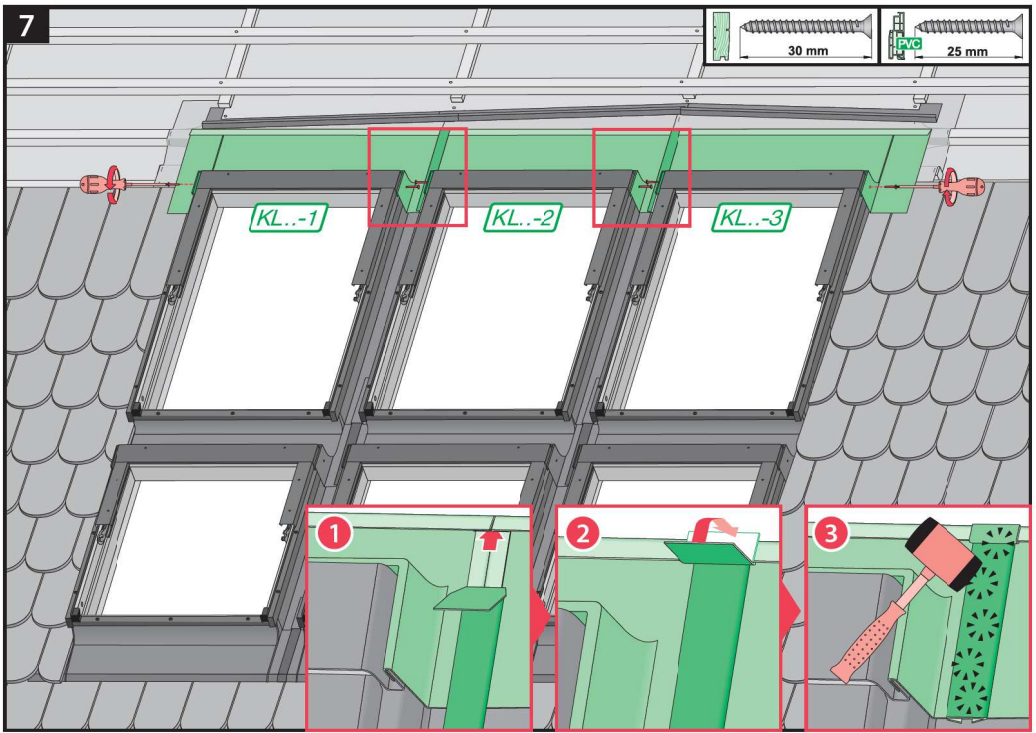

B2/2

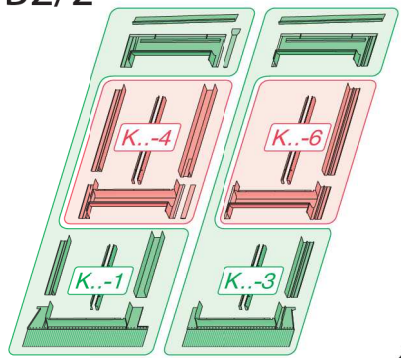

B3/2

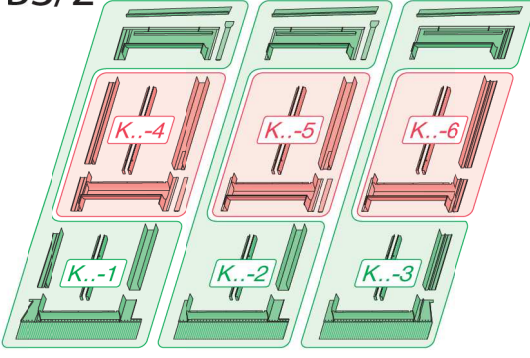

B4/2

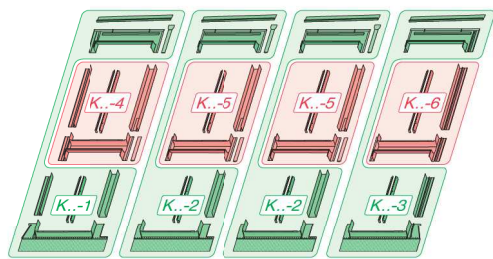

B2/3

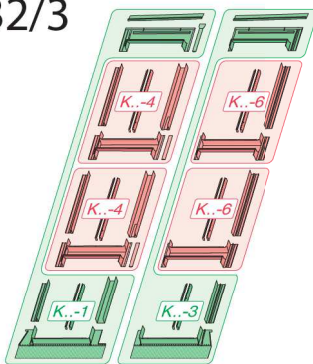

B3/3

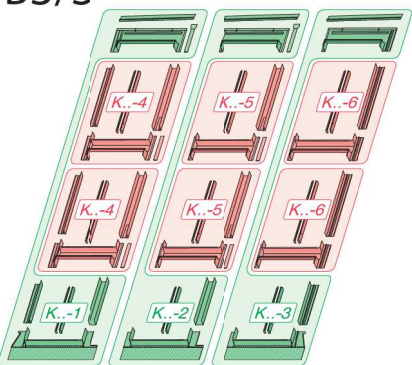

B4/3

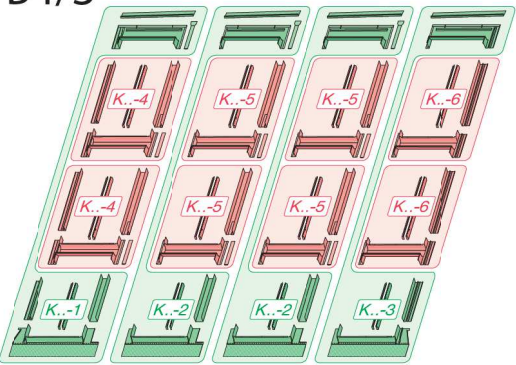

0 [cm] 1 2 3 4 5 6 7 8 9 10 11 12 13 14

CZ Vyrobcé ani prodávce nenosí žádnou odpovědnost za dodržení příslušných platných zákonů, stavebních předpisů a bezpečnostních požadavků uživatelů výrobku, architektů, montážníků nebo vlastních budov.

ES El fabricante y el vendedor no tienen ninguna responsabilidad por el incumplimiento de la ley vigente, normas de construcción y exigencias de seguridad por parte del usuario del producto, arquitectos, instalador o el propietario del edificio.

GB Manufacturer and Seller shall bear no liability for failure to comply with the applicable laws, building codes and safety requirements by the user of the product, architect, fitter or owner of the building.

IT Il Produttore e il Rivenditore non potranno essere ritenuti responsabili per il mancato rispetto, da parte dell'utente del prodotto, del progettista, dell'installatore e del proprietario dell'edificio, delle leggi vigenti, nonché dei regolamenti edilizi e di quelli relativi alla sicurezza.

PL Producent i Sprzedawca nie ponosi żadnej odpowiedzialności za nieprzestrzeganie stosownych przepisów prawa, przepisów budowlanych i wymogów bezpieczeństwa przez użytkownika produktu, architekta, montażystę lub właściciela budynku.

RO Nici producătorul, nici distribuătorul nu sîi vor asuma niciun fel de rîspundere pentru nerespectarea legilor în vigoare, a legilor din domeniul construcțiilor sau a măsurilor de siguranță impuse utilizatorilor produsului, arhitecților, montajistilor sau proprietarilor clădirii.

SK Vytvorca a predávca nenesú žiadnu zodpovednosť za nedodržanie príslušných ustanovení zákona, stavebných predpisov a bezpečnostných požiadaviek užívateľov výrobku, architektov, montážnikov alebo majiteľov objektu.

DE Hersteller und Verkäufer übernehmen keine Haftung für Nichtbeachtung entsprechender rechts- und Bauvorschriften sowie Sicherheitsanforderungen seitens Produktbenutzers, Architekten, Monteurs oder Gebäudebesitzer.

FR Le fabricant et le vendeur ne prend aucune responsabilité de ne pas respecter les lois applicables, les règlements sur les bâtiments et les exigences de sécurité par l'utilisateur du produit, l'architecte, l'installateur ou le propriétaire du bâtiment.

HU A Gyártó és a Forgalmazó nem vállal semmiféle felelősséget a vonatkozó törvényi, építési és biztonsági előírások teremtéshatáskál, építész, telepítésmester vagy épületajdónos által be nem tartásáért.

NL De fabrikant en verkoper zijn niet aansprakelijk voor gevolgen bij het niet opvolgen van toepasselijke wetten, bouwbesluiten en veiligheidsvoorschriften door de gebruiker van het product, de architect, de installateur of de eigenaar van het gebouw.

PT O fabricante e o vendedor não tem nenhuma responsabilidade pelo o não cumprimento da lei, códigos de construção e as exigências de segurança por parte do usuário do produto, arquiteto, instalador ou proprietário do edifício.

RU В случае несоблюдения архитектором, монтажником или владельцем здания строительных правил и норм безопасности ответственность с производителя и продавца снимается.