

# ZWZ230 ZRD

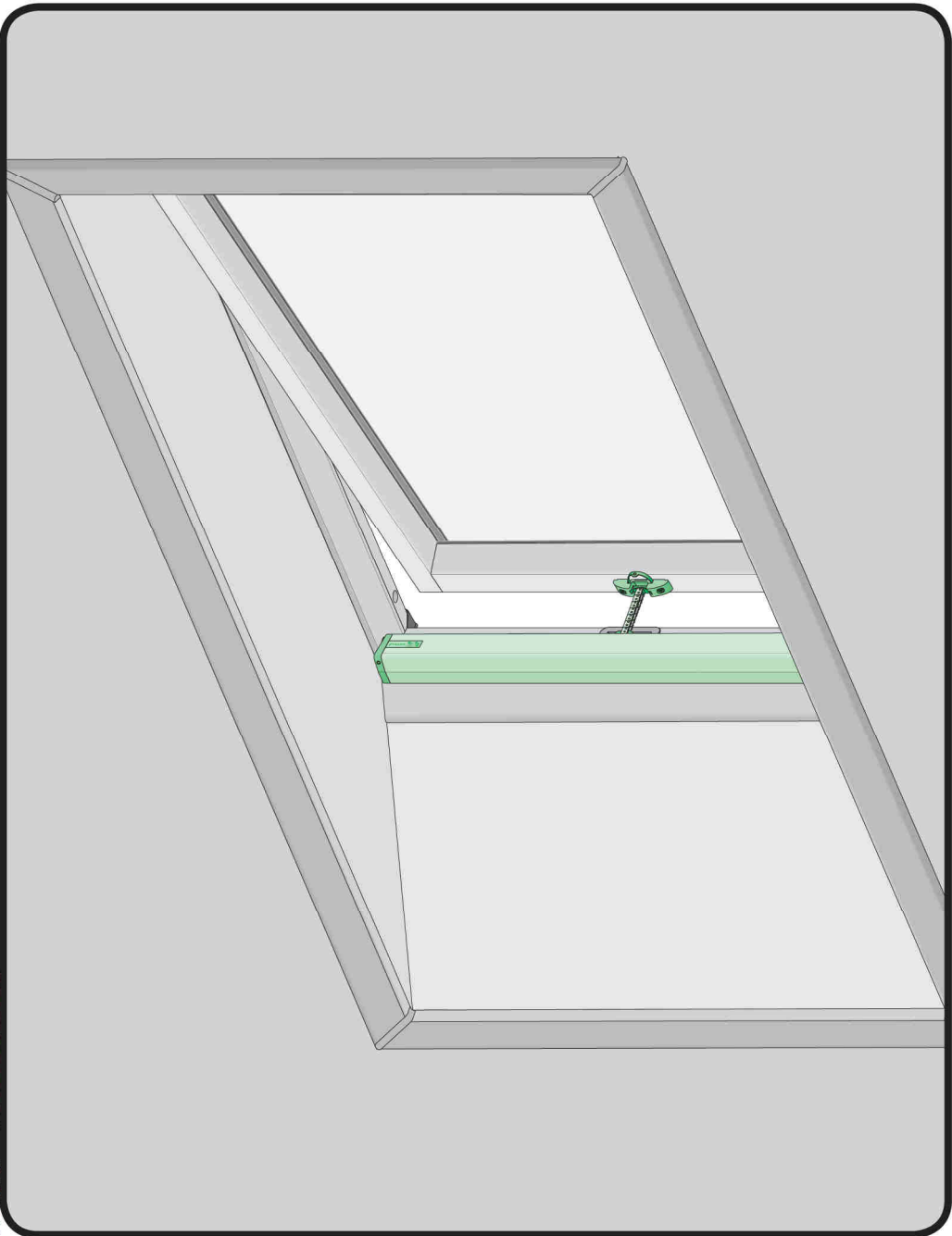

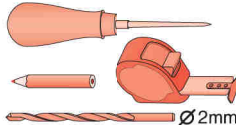

## ZWZ230 ZRD

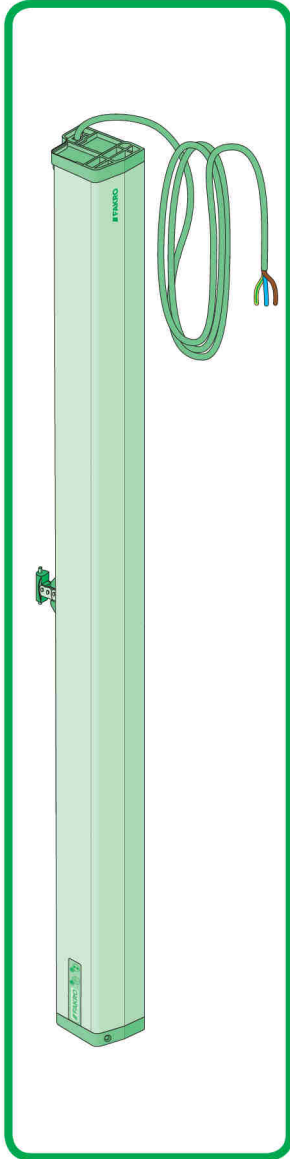

### ZRH12

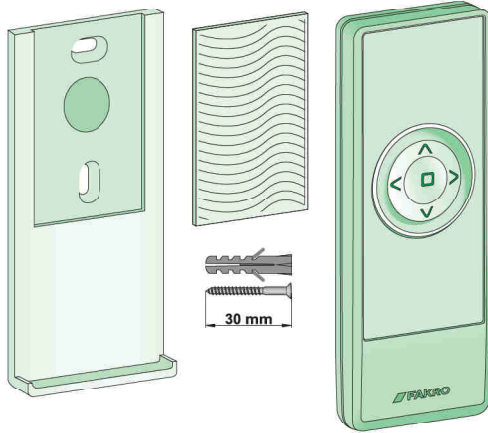

### ZRD

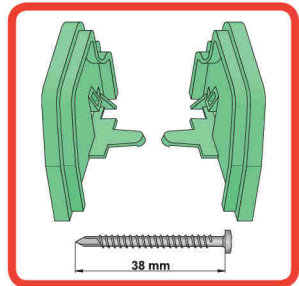
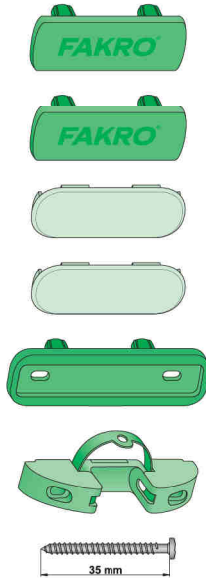
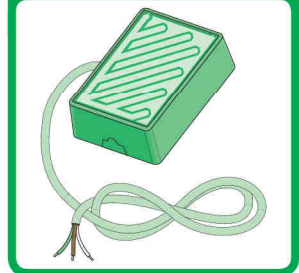

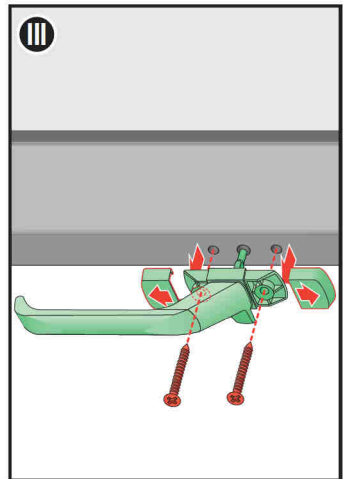
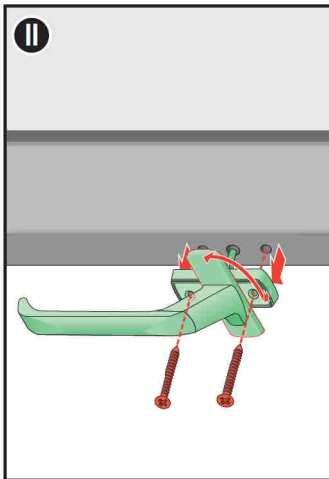
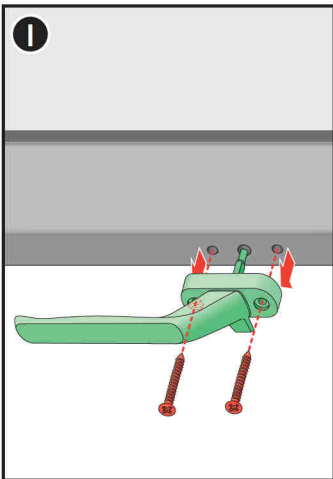
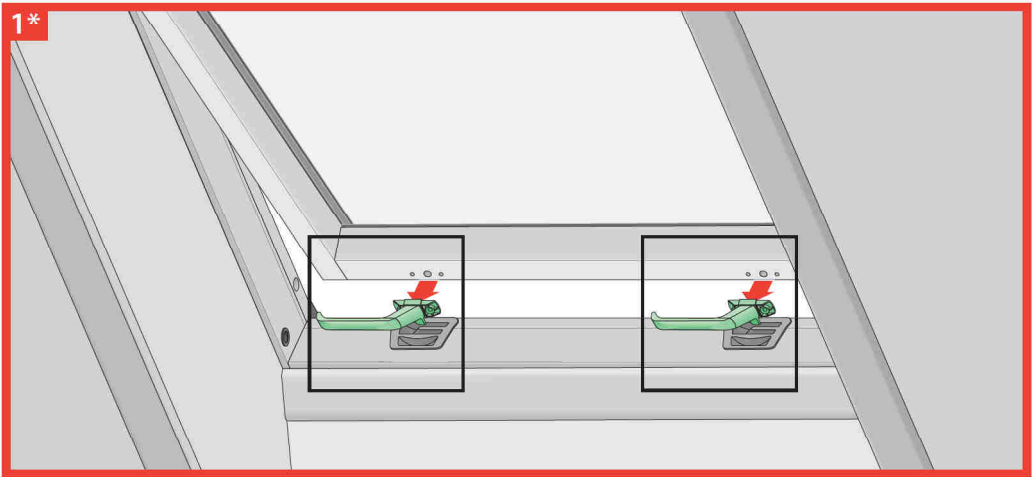
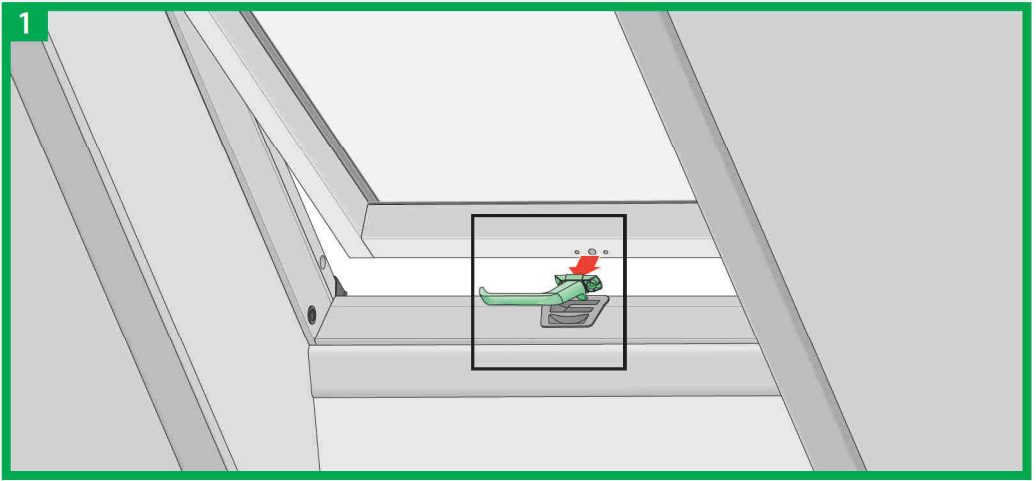

2

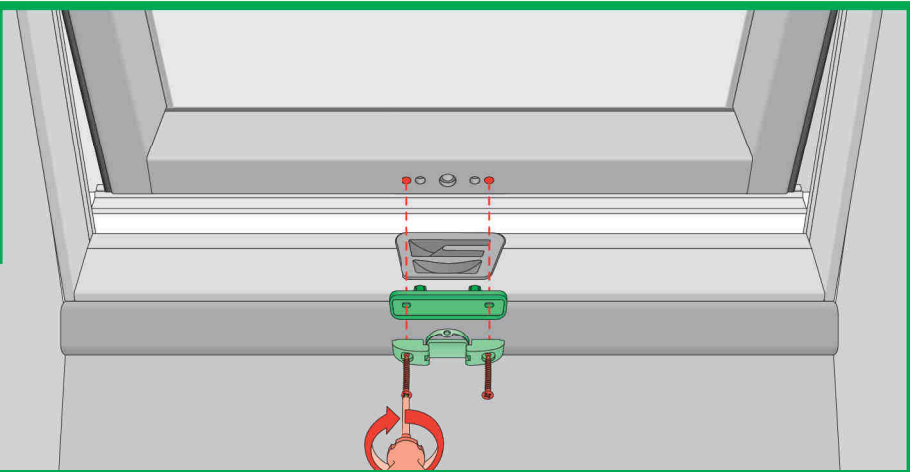
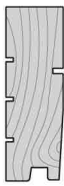

2a

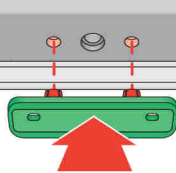

2b

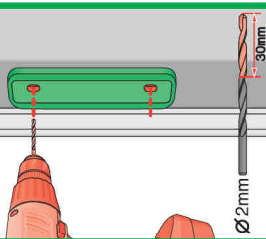

2c

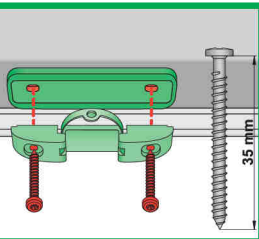

2\*



PVC

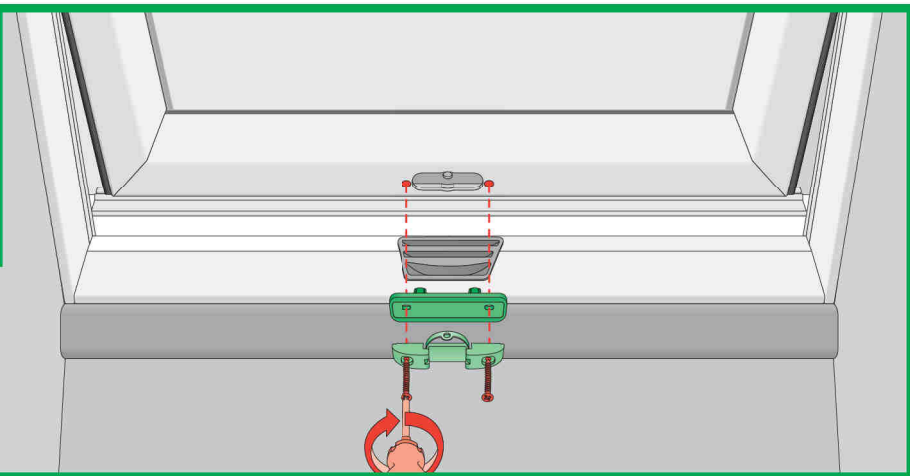

2a

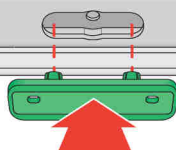

2b

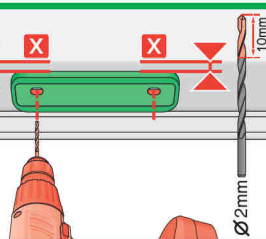

2c

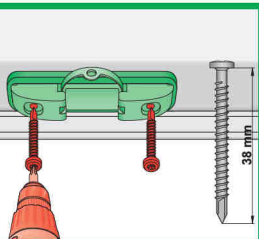

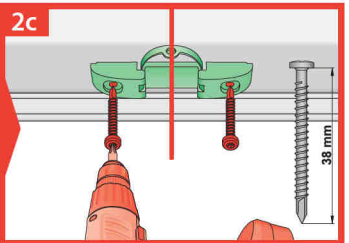
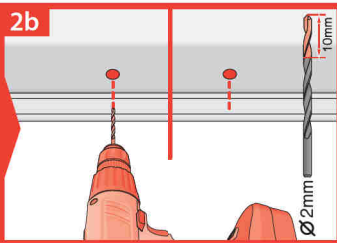
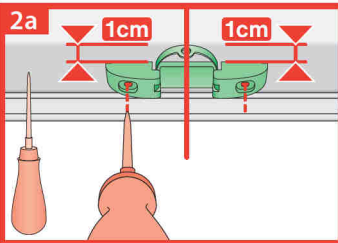
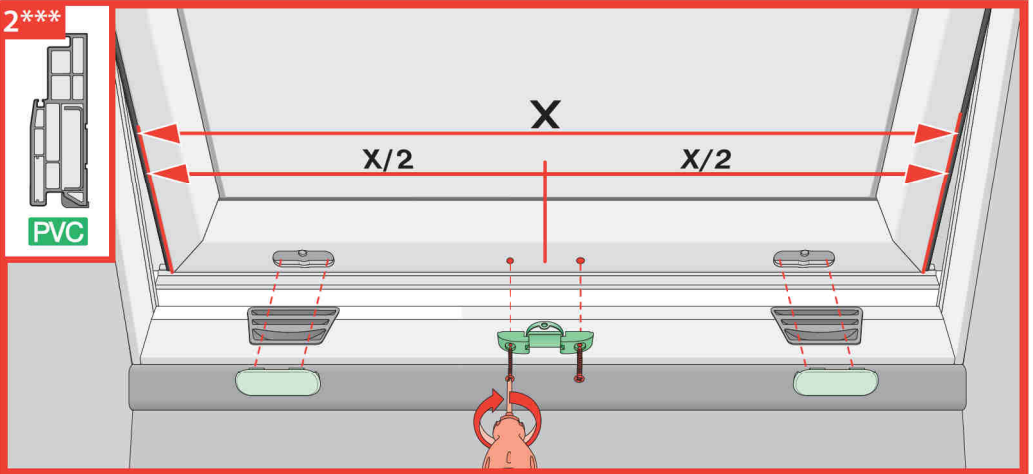
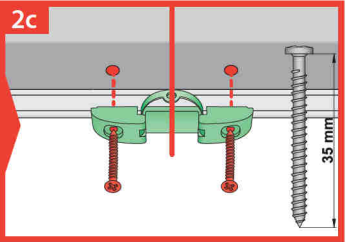
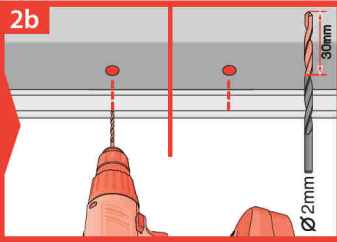
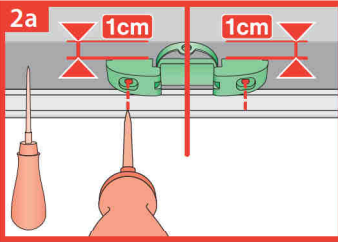
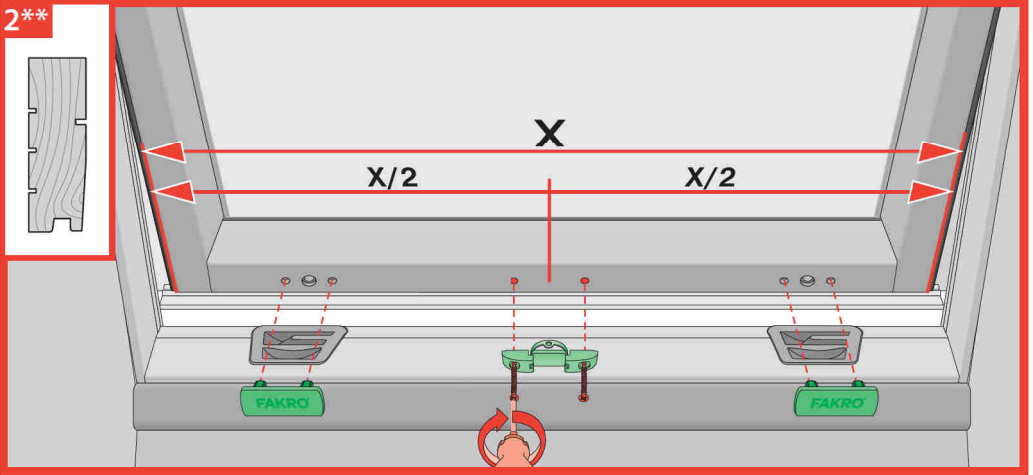

3a

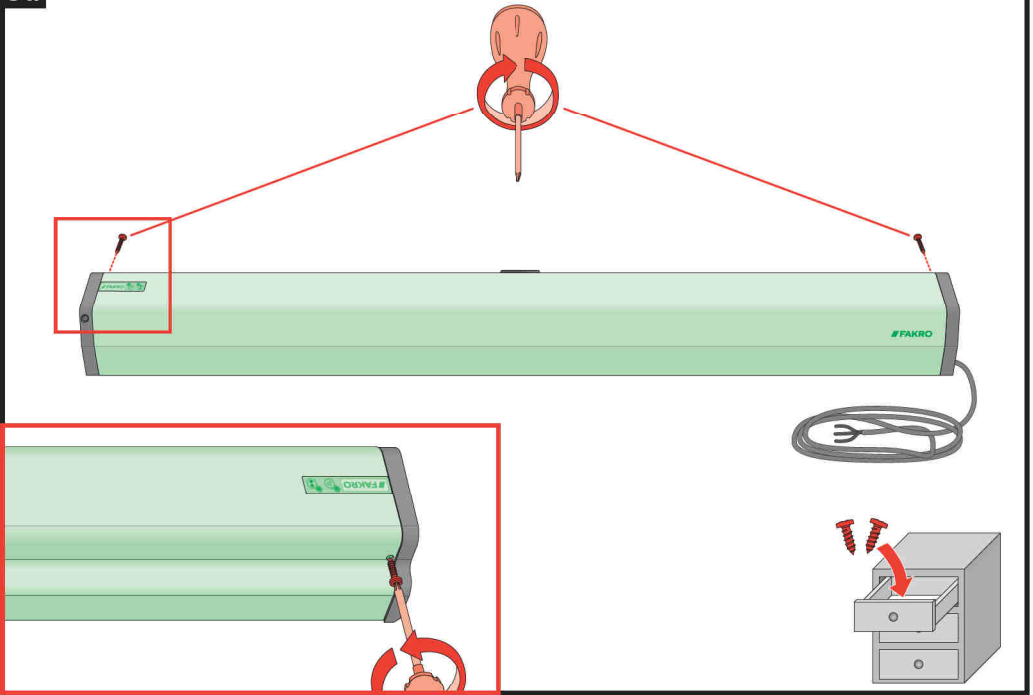

3b

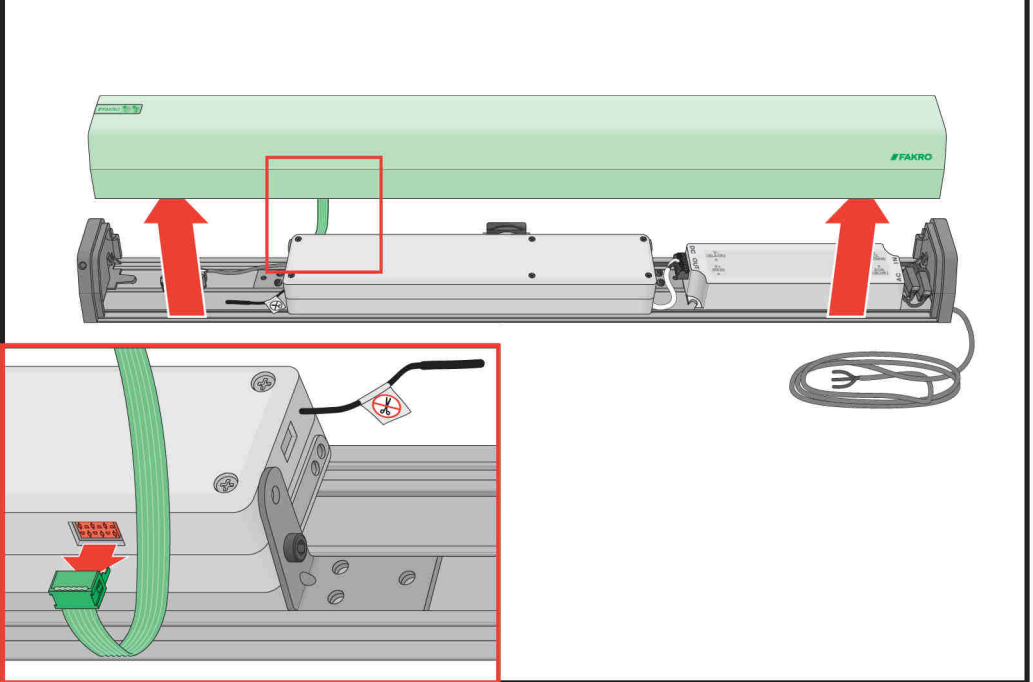

3\*

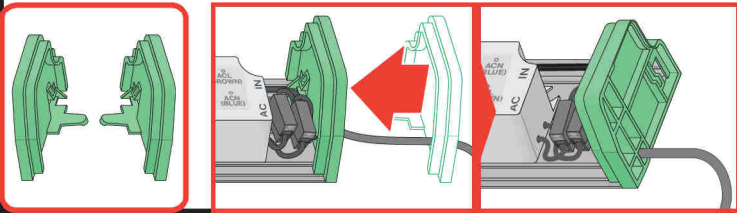
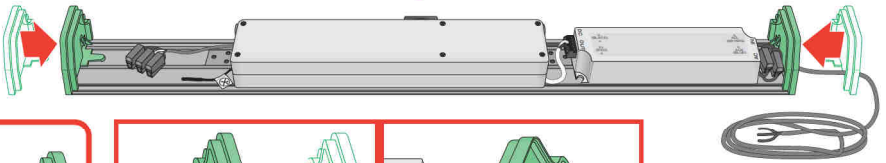
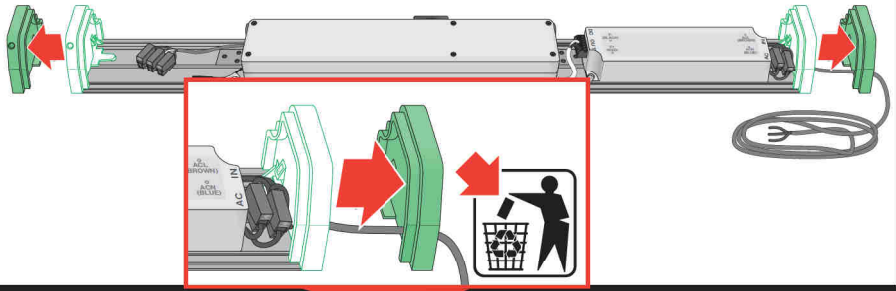
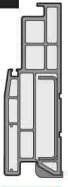

4

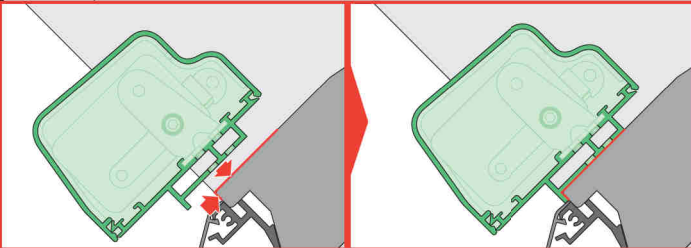
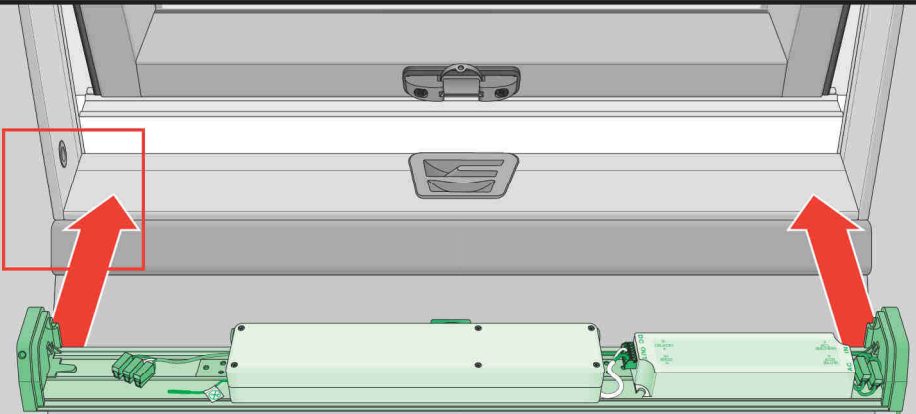

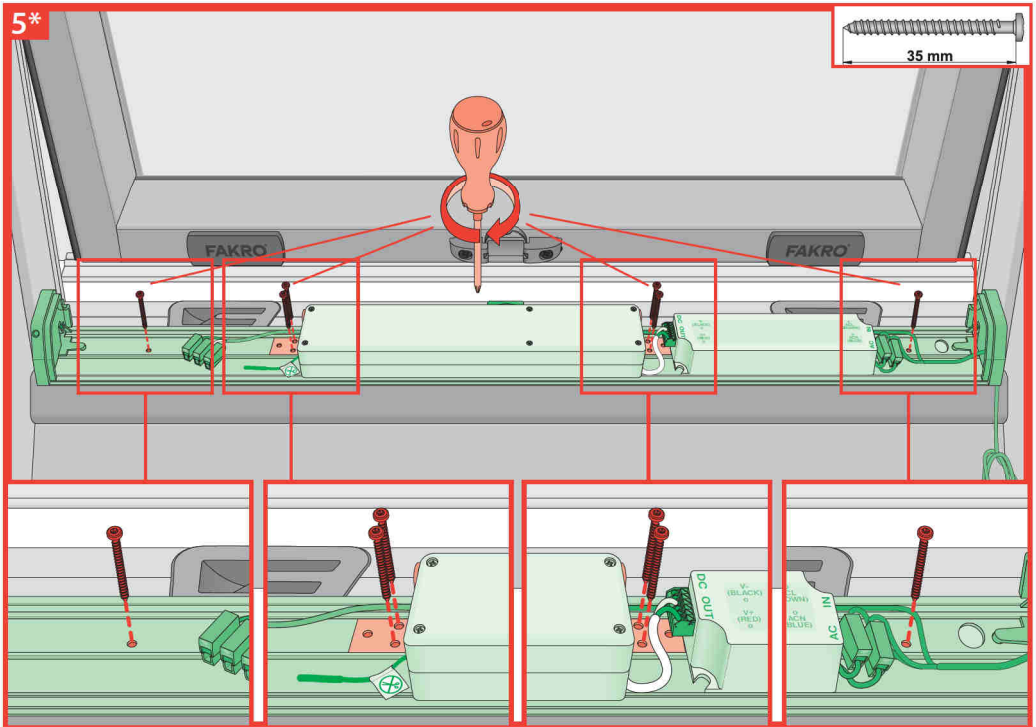
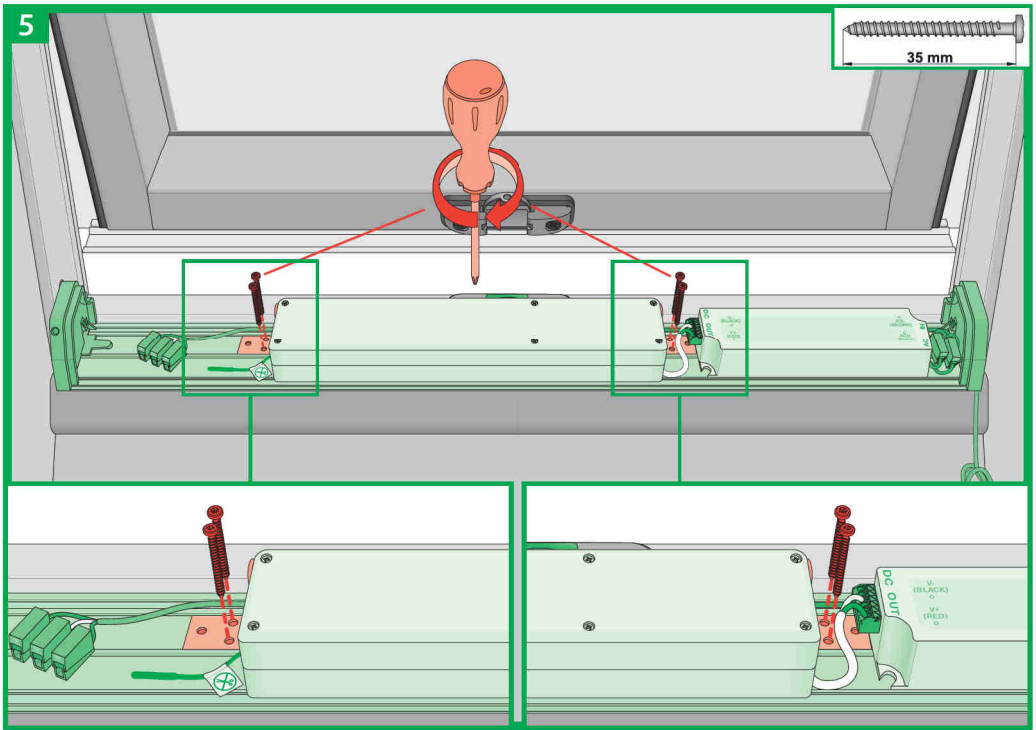



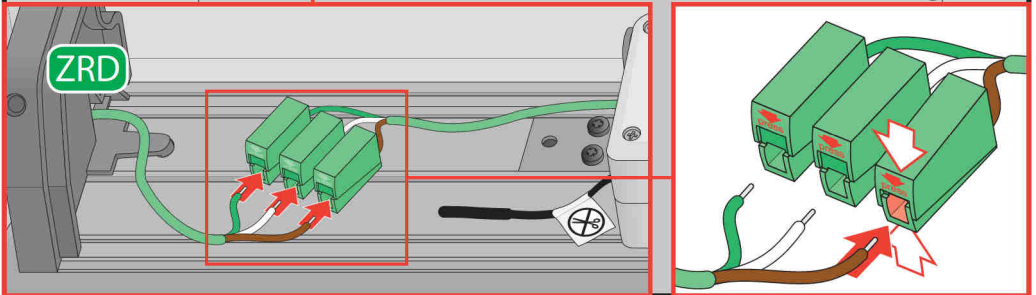
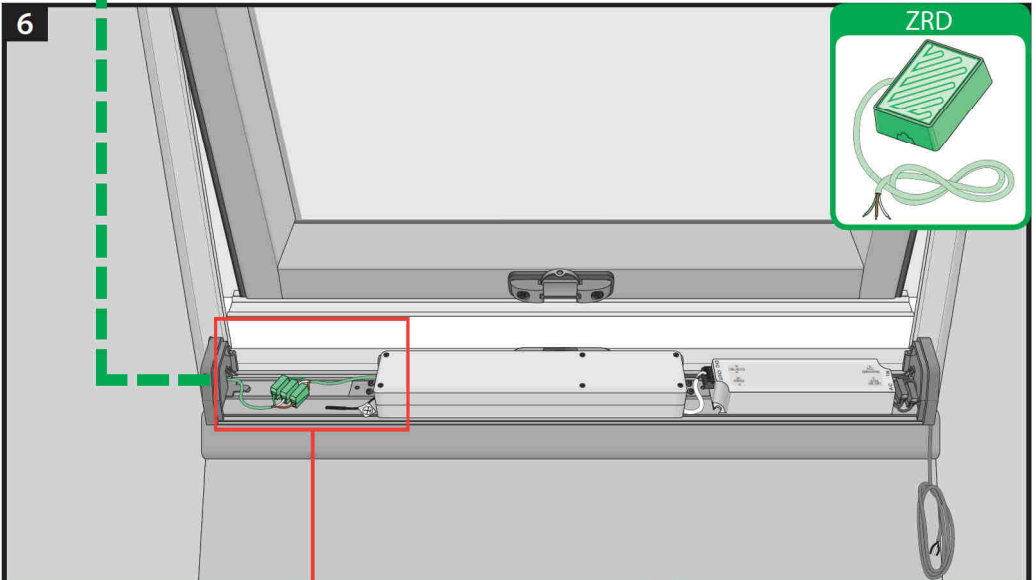
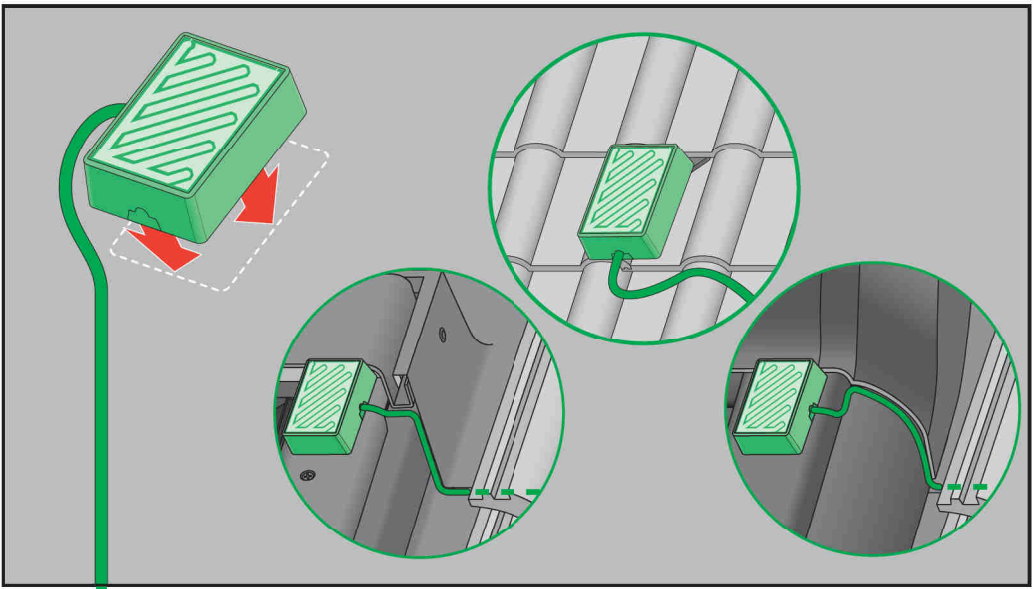

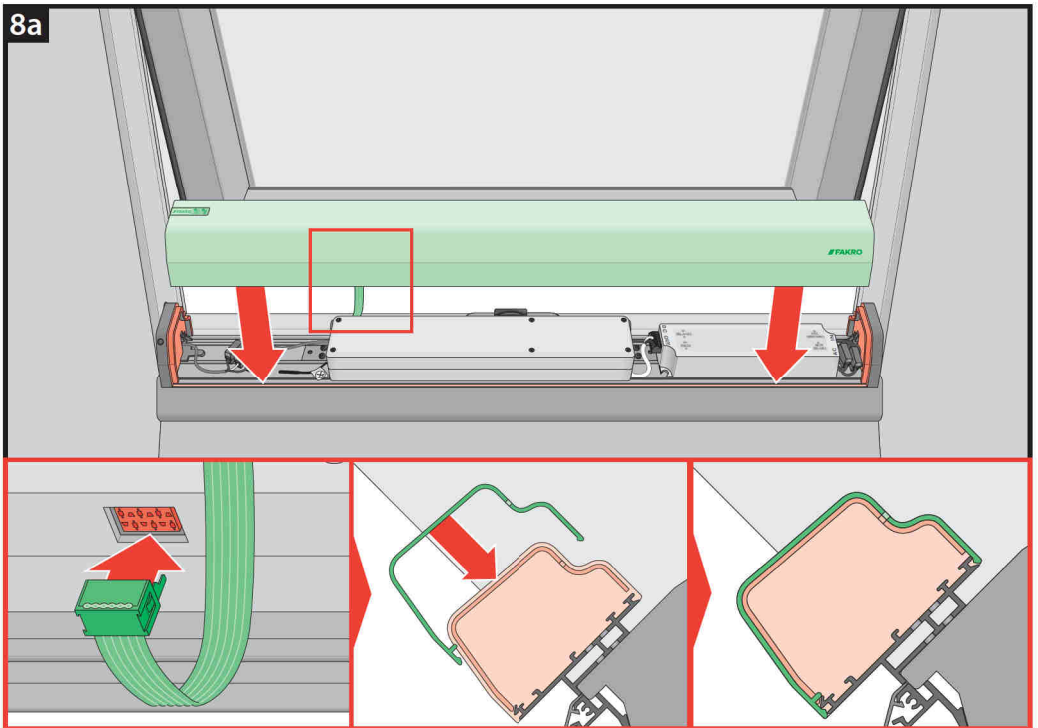
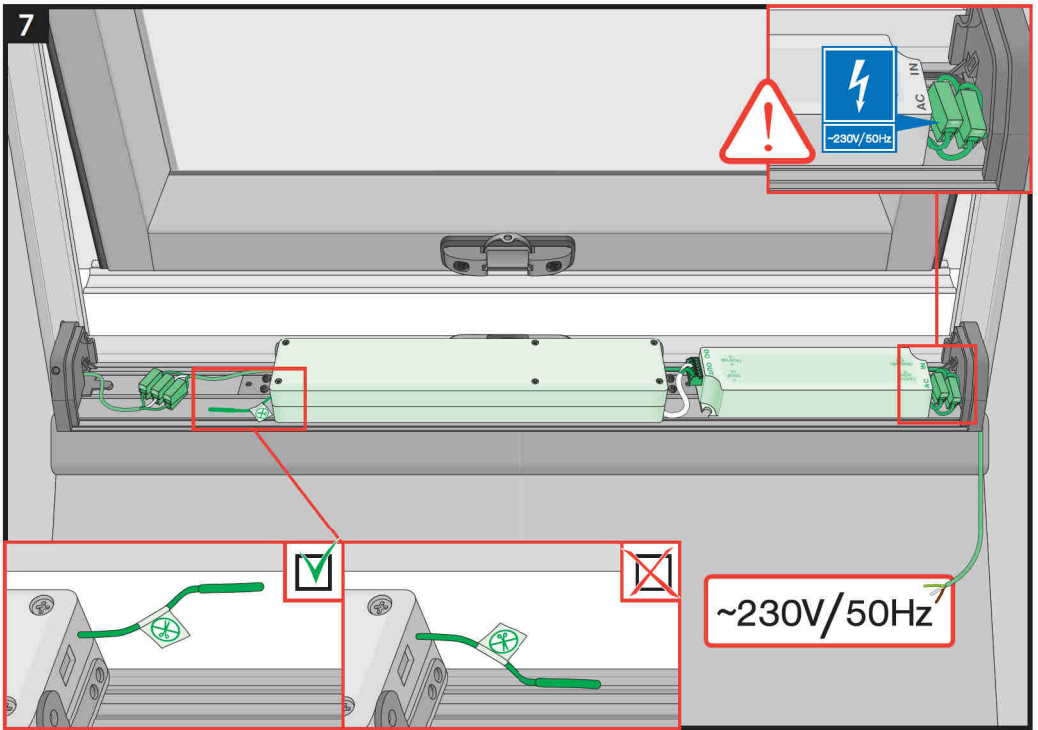

8b

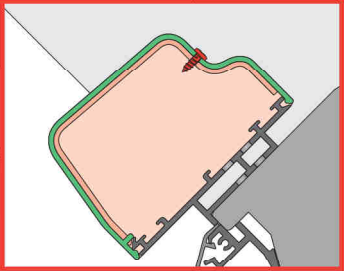
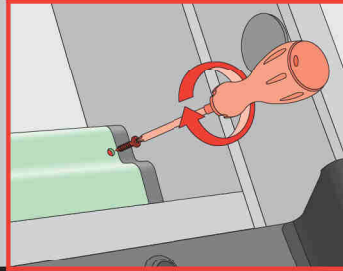
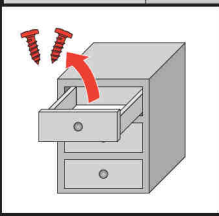
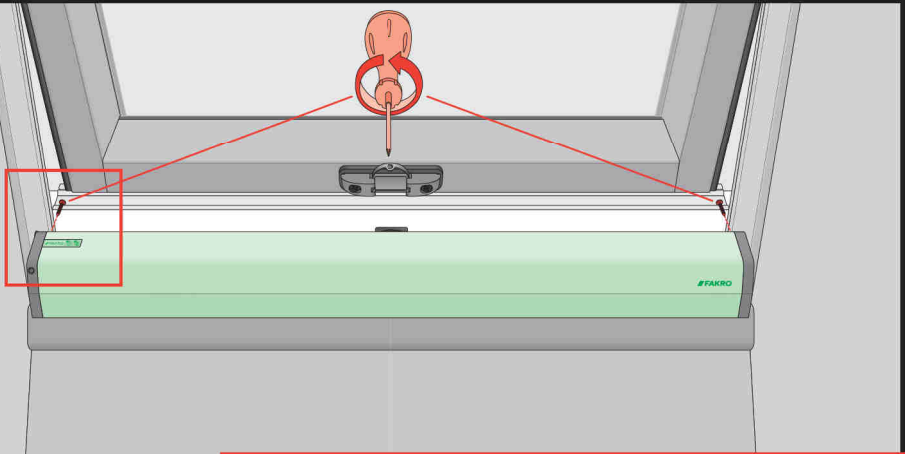

9a

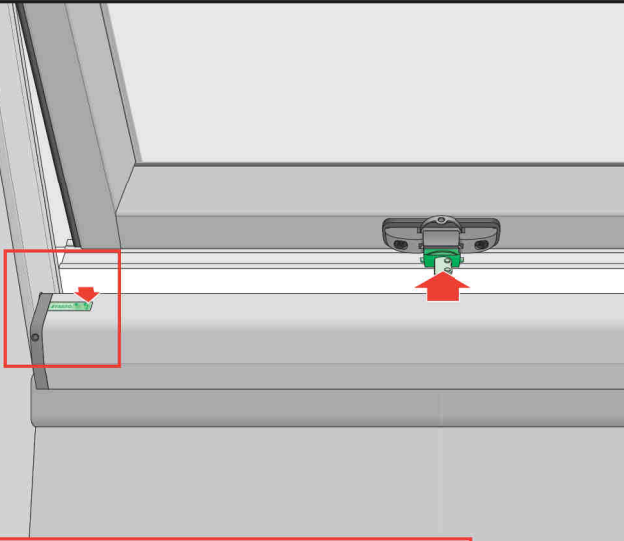

9b

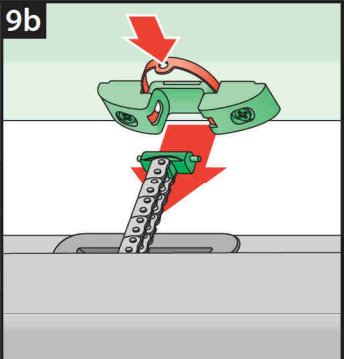

9c

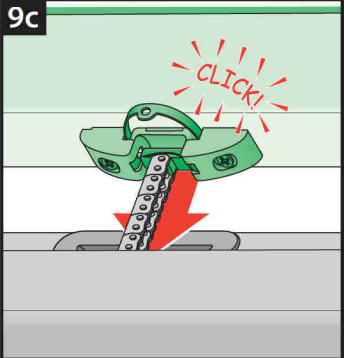

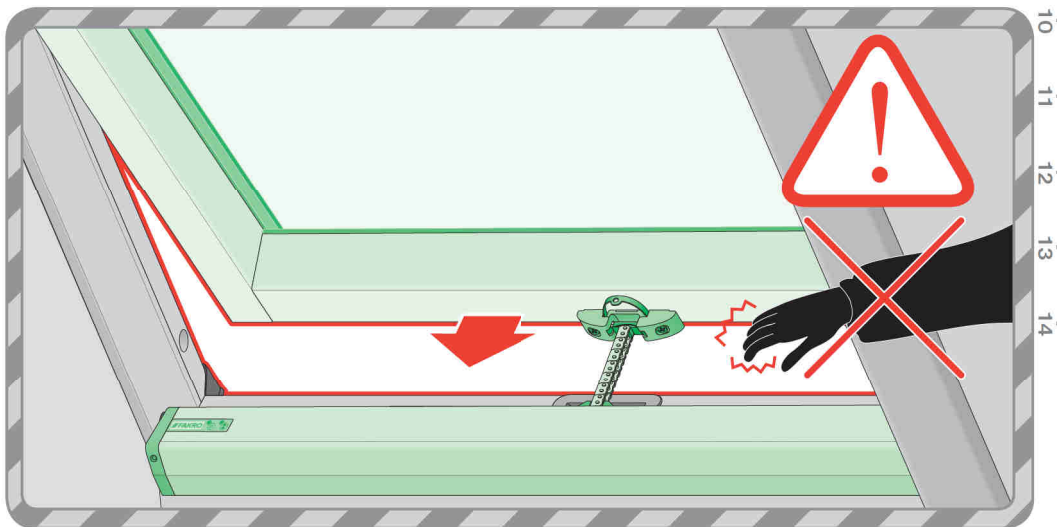
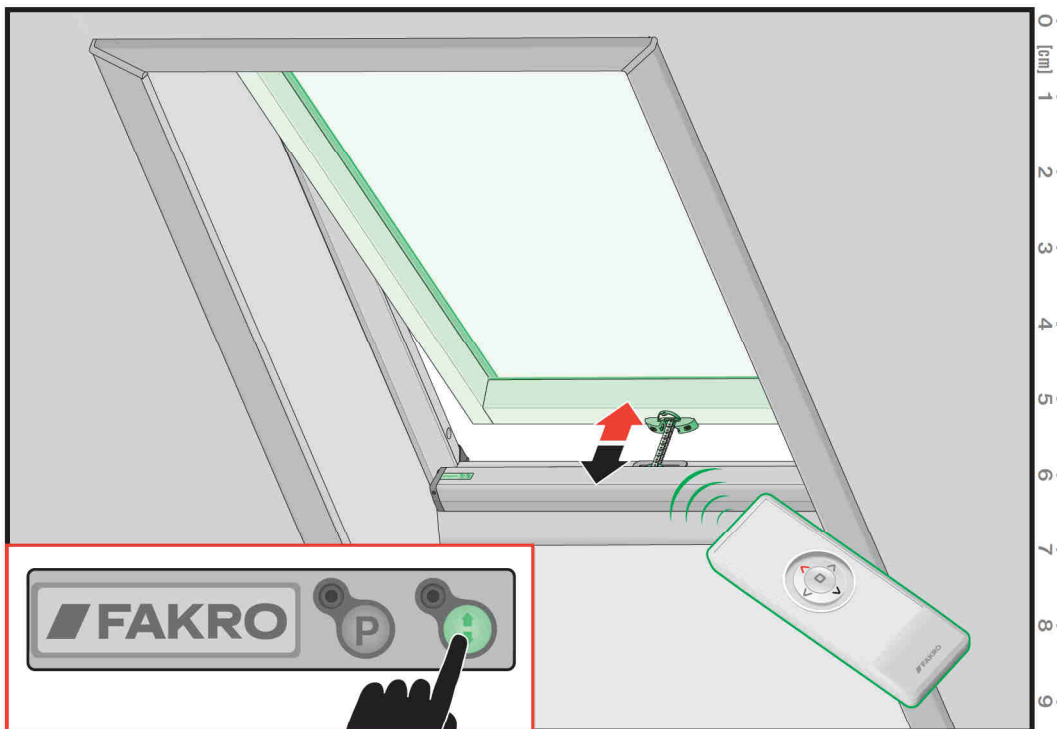

**CZ** Výrobce a prodejce nenesú žádnou zodpovednosť za neobdobrenú príslušnými ustanovení zákona, stavebných predpisů a bezpečnostních požadavků uživatelem výrobku, architektem, montérem nebo majitelem objektu.  
**ES** El fabricante y el vendedor no tienen ninguna responsabilidad por el incumplimiento de la ley vigente, normas de construcción y exigencias de seguridad por parte del usuario del producto, arquitecto, instalador o el propietario del edificio.  
**GB** Manufacturer and Seller shall bear no liability for failure to comply with the applicable laws, building codes and safety requirements by the user of the product, architect, fitter or owner of the building.  
**IT** Il Produttore e il Rivenditore non potranno essere ritenuti responsabili per il mancato rispetto, da parte dell'utente del prodotto, del progettista, dell'installatore o del proprietario dell'edificio, delle leggi vigenti, nonché dei regolamenti edilizi e di quelli relativi alla sicurezza.  
**PL** Producent i Sprzedawca nie ponosi żadnej odpowiedzialności za nieprzeżyczenie stosownych przepisów prawa, przepisów budowlanych i wymogów bezpieczeństwa przez użytkownika produktu, architekta, montażystę lub właściciela budynku.  
**RO** Nici producătorul, nici distribuătorul nu sîr vor asuma niciun fel de răspundere pentru nerespectarea legilor în vigoare, a legilor din domeniul construcțiilor sau a măsurilor de siguranță impuse utilizatorilor produsului, arhitecților, montajorilor sau proprietarilor clădirii.  
**SK** Výrobca a predávca nenesú žiadnu zodpovednosť za neobdobrenú príslušnými ustanovení zákona, stavebných predpisů a bezpečnostních požadavků uživatelem výrobku, architektom, montérom alebo majiteľom objektu.

**DE** Hersteller und Verkäufer übernehmen keine Haftung für Nichtbeachtung entsprechender Rechts- und Bauvorschriften sowie Sicherheitsanforderungen seitens Produktbenutzers, Architekten, Monteurs oder Gebäudebesizers.  
**FR** Le fabricant et le revendeur ne prend aucune responsabilité de ne pas respecter les lois applicables, les règlements sur les bâtiments et les exigences de sécurité par l'utilisateur du produit, l'architecte, l'installateur ou le propriétaire du bâtiment.  
**HU** A gyártó és a forgalmazó nem vállal semmiféle felelősséget a vonatkozó törvényi, építési és biztonsági előírások, építész, beépítőmester vagy épületlajdosok általi be nem tartásáért.  
**NL** De fabrikant en verkoper zijn niet aansprakelijk voor gevolgen bij het niet opvolgen van toepasselijke wetten, bouwbesluiten en veiligheidsvoorschriften door de gebruiker van het product, de architect, de installateur of de eigenaar van het gebouw.  
**PT** O fabricante e o vendedor não tem nenhuma responsabilidade pelo o não cumprimento da lei, códigos de construção e as exigências de segurança por parte do usuário do produto, arquiteto, instalador ou proprietário do edifício.  
**RU** В случае несоблюдения архитектором, монтажником или владельцем здания строительных правил и норм безопасности ответственность с производителя и продавца снимается.